

CD RECEIVER

KDC-MP6025/MP625 /MP858 /W6527/W6527Y SERVICE MANUAL

KENWOOD

© 2004-1 PRINTED IN JAPAN
B53-0124-00 (N) 2704

CD MECHANISM EXTENSION CORD (24P) : W05-0935-00

KDC-MP6025 (K3)
KDC-MP625 (K2)

Panel assy
(A64-3213-02) :K2
(A64-3214-02) :K3

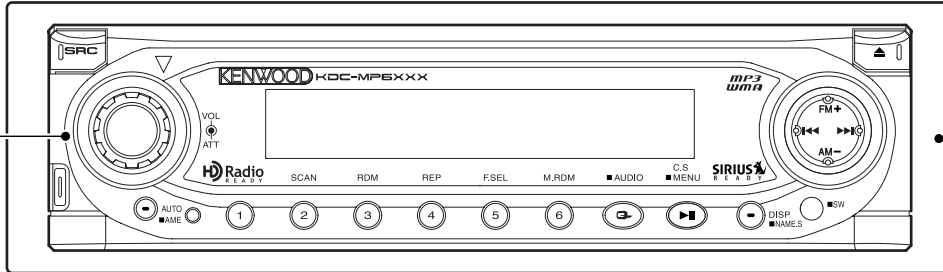

Escutcheon
(B07-3098-02) :K2
(B07-3100-02) :K3

KDC-MP858 (M1)

Panel assy
(A64-3215-02)

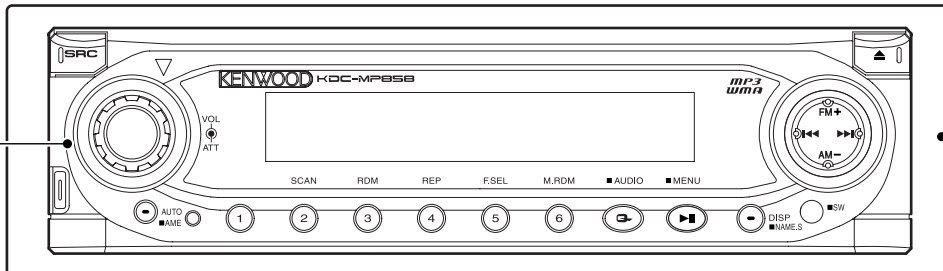

Escutcheon
(B07-3098-02)

KDC-W6527 (E)
KDC-W6527Y (E1)

Panel assy
(A64-3217-02)

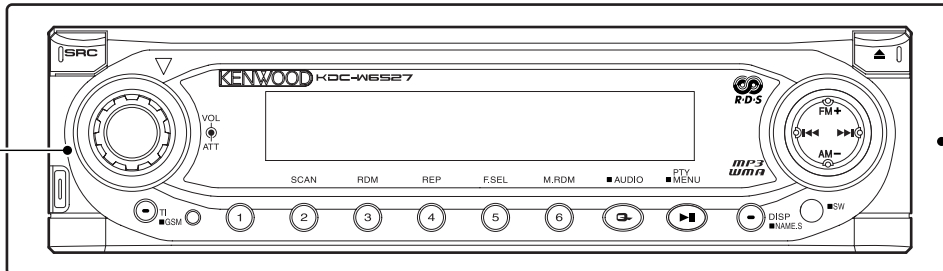

Escutcheon
(B07-3083-02)

Plastic cabinet assy
(A02-2732-03)

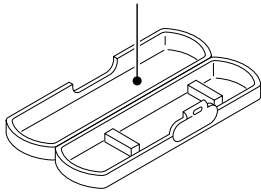

Lever
(D10-4589-04) x2

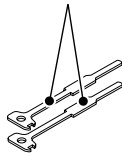

Mounting hardware assy
(J21-9716-03)

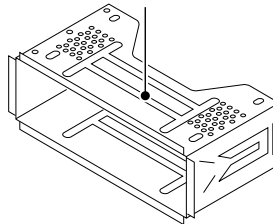

DC cord
(E30-6294-05) :M1
(E30-6295-05) :K2K3

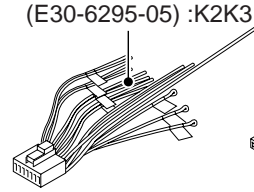

DC cord
(E30-6063-15) :EE1

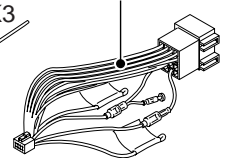

Remote controller assy (RC-505)
(A70-2059-05) :K2K3M1

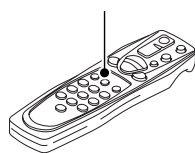

Size AA battery
(Not supplied) :K2K3M1



Remote controller assy (RC-420)
(A70-2055-05) :EE1

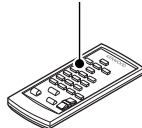

Screw
(N09-6212-05)



Screw set
(N99-1723-05) :K2K3M1

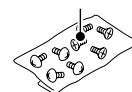

Antenna adaptor
(T90-0523-05) :EE1

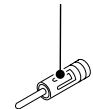

TDF PANEL INFORMATION

MODEL	TDF PANEL No.	TDF NAME
KDC-MP625/MP858	Y33-1990-61	TDF-46D
KDC-MP6025	Y33-1990-62	TDF-46DB
KDC-W6527/W6527Y	Y33-1990-63	TDF-W6527



BLOCK DIAGRAM

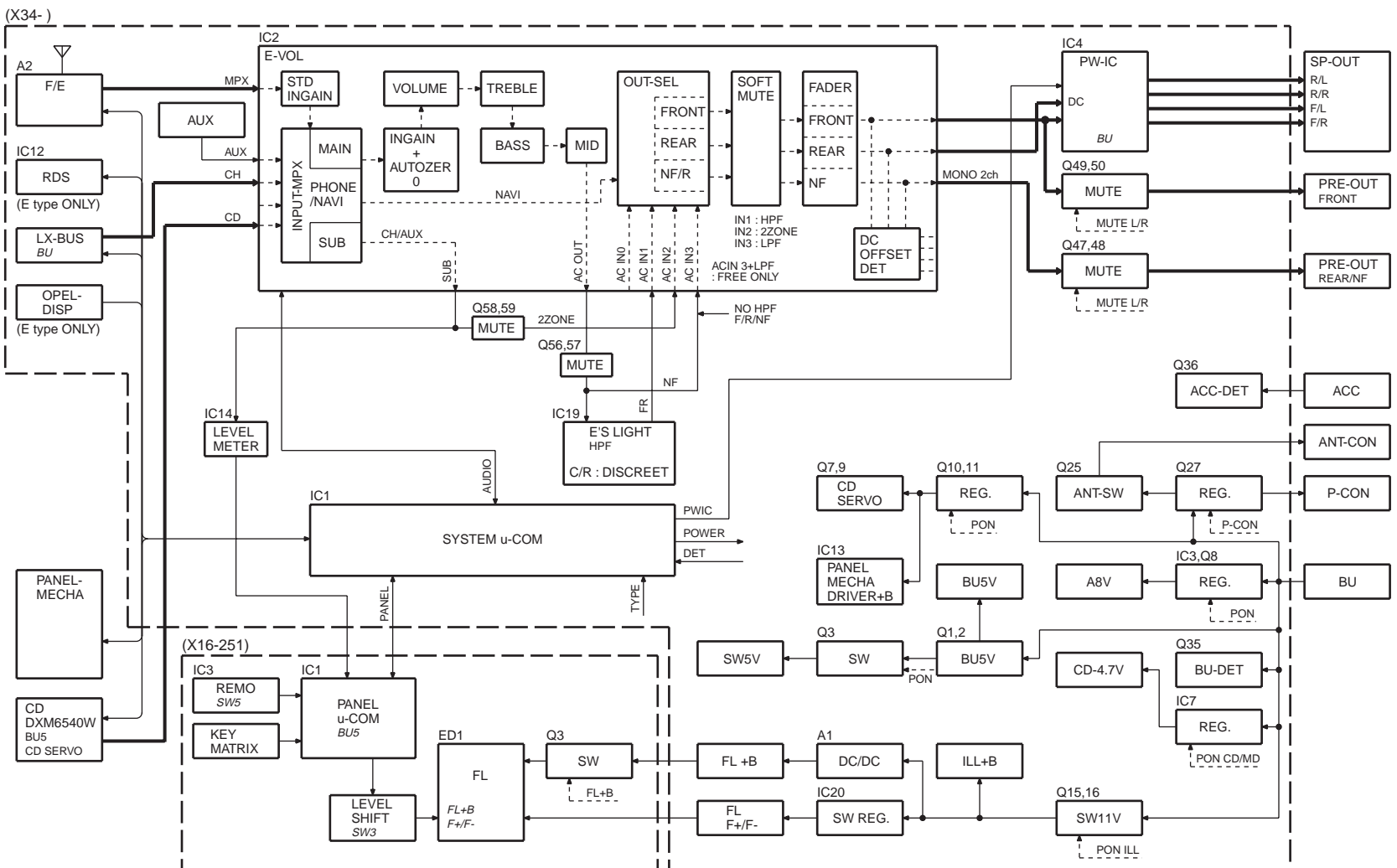

COMPONENTS DESCRIPTION

● SUB-CIRCUIT UNIT (X16-2510-10/X16-2722-70)

Ref. No.	Application / Function	Operation / Condition / Compatibility
IC1	Panel μ com	
IC2	3.3V Regulator	The power supply of IC and VFD (Logic) which are driven by 3.3V
IC3	Remote Control IC	
IC4	Buffer IC	It is change into 3.3V from 5V
Q1	FL BLK SW	VFD is turned on when Q1's base level goes "H"
Q2,3	FL+B SW	FL+B (VDD2) is turned on when Q2's base level goes "H"
Q4	SW5V	The power supply of IC3 is turned on when Q4's base level goes "L"
Q6	∇ LED SW	∇ LED is turned on when Q6's base level goes "H"
Q7,9	Red LED SW	RED LED is turned on when Q7's base level goes "L"
Q8,10	Green LED SW	GREEN LED is turned on when Q8's base level goes "L"
Q11,12	Blue LED SW	BLUE LED is turned on when Q11's base level goes "L"

● ELECTRIC UNIT (X34-301x-xx/X34-3222-70)

Ref. No.	Application / Function	Operation / Condition / Compatibility																	
IC1	System μ COM	Controls FM/AM tuner, the changer, CD/MD mechanism, Panel, volume and tone.																	
IC2	E.Vol & N.C.MPX	Controls the source, volume, tone and FM multiplex detector																	
IC3	A8V Ref Power Supply	Output 1.27V																	
IC4	Power IC	Amplifies the front L/R and the rear L/R to 50W or 47W maximum.																	
IC7	SW Regulator	Power Supply for mp3																	
IC10	Muting logic IC	Controls logic for muting.																	
IC11	Reset IC	"L" when detection voltage goes below 3.6V or less.																	
IC12	RDS decoder																		
IC13	Panel mecha motor driver	Panel mecha control <table border="1" style="margin-left: 20px;"> <thead> <tr> <th colspan="2">IN</th> <th rowspan="2">Panel mecha</th> </tr> <tr> <th>IN1</th> <th>IN2</th> </tr> </thead> <tbody> <tr> <td>L</td> <td>L</td> <td>WAIT</td> </tr> <tr> <td>L</td> <td>H</td> <td>OPEN</td> </tr> <tr> <td>H</td> <td>L</td> <td>CLOSE</td> </tr> <tr> <td>H</td> <td>H</td> <td>STOP</td> </tr> </tbody> </table>	IN		Panel mecha	IN1	IN2	L	L	WAIT	L	H	OPEN	H	L	CLOSE	H	H	STOP
IN		Panel mecha																	
IN1	IN2																		
L	L	WAIT																	
L	H	OPEN																	
H	L	CLOSE																	
H	H	STOP																	
IC14	Level meter Buffer	The signal of IC2 is sent to Panel μ com																	
IC20	SW Regulator	Power Supply for VFD																	
Q1,2	B.U.5V AVR	While BU is applied, BU5V AVR outputs +5V.																	
Q3,4	SW5V	When Q4'base goes Hi, SW5V outputs +5V.																	
Q5	SW14V	When Q5'2pin goes Hi, SW14V outputs 14V.																	
Q6,8	AUDIO8V AVR	When Q6'2in goes Hi, A8V AVR outputs 8.0V.																	
Q7,9	SERVO+B AVR	When Q9'base goes Hi, S+B AVR outputs 7.5V.																	
Q10,11	SERVO+B AVR (Panel Mecha)	When Q10'base goes Hi, S+B AVR outputs 8.5V.																	
Q12	SW for IC7	When Q12'base gose Lo, IC7 is turned on.																	

COMPONENTS DESCRIPTION

Ref. No.	Application / Function	Operation / Condition / Compatibility
Q13,15,16	FL&ILL AVR	When Q13'2pin goes Hi, ILL AVR outputs 10.5V.
Q25,26	P-ANT SW	When Q23'base goes Hi, P-ANT SW outputs 14V.
Q27,30	P-CON SW	When Q30'base goes Hi, AVR outputs 14V.
Q28,29	P-CON Protection	Protect Q27 by turning on when P-CON output is grounded.
Q31	Ex Amp Control Buffer	
Q32	Small lamp det SW	When Q32'base goes Hi, Q32 is turned on.
Q33,34	SERGE Det.	When Q33'base goes Hi, IC4 is changed into a standby state.
Q35	BU det	When Q35'base goes Hi, Q27 is turned on.
Q36	ACC det	When Q36'base goes Hi, Q29 is turned on.
Q37,38	Pre-out mute driver	When a base goes Lo, mute driver is turned on.
Q39	Sub-out mute driver	When a base goes Lo, mute driver is turned on.
Q40	AC-out mute driver	When a base goes Lo, mute driver is turned on.
Q41,42	AM+B SW	When Q42'base goes Hi, AM+B is out.
Q43	Composite signal buffer for RDS	
Q44	DSI Driver	DSI lights when the base is "L". DSI turns off when the base is "H". DSI turns on and off when panel is taken off.
Q45,46	Panel 5V SW	When Q46'base goes Hi, PANEL 5V is out.
Q47~50	Pre-out mute SW	When a base goes Hi, Pre-out is muted.
Q55	Noise buffer	RDS Noise
Q56,57	AC-out mute SW	When a base goes Hi, AC-out is muted.
Q58,59	Sub-out mute SW	When a base goes Hi, Sub-out is muted.
Q60	Level meter mute SW	When a base goes Hi, Level meter is muted.

MICROCOMPUTER'S TERMINAL DESCRIPTION

● SYSTEM MICROCOMPUTER : 30624MGPA27GP (X34 : IC1)

Pin No.	Pin Name	Module	I/O	Application	Truth Value Table	Processing Operation Description
1~4	NC		O	Not used		Output : L
5	OPEL_REMO	EXTRA	I	External display remote control input		
6	BYTE		-			0V GND direct connection
7	CNVSS		I	Used when writing to system μ com		Pull down
8	XCIN		I	Sub clock input (32.768kHz)		
9	XCOU		I	Sub clock output (32.768kHz)		
10	RESET		-	Reset terminal		L : Reset
11	XOUT		-	Main clock output (16.0MHz)		
12	VSS		-			
13	XIN		-	Main clock input (16.0MHz)		
14	VCC1		-			
15	NMI		I	Not used		
16	ES_SW	EXTRA	O	System E's light usage switching	⑦	L : FLAT, H : E's Light
17	RDS_CLK	TUNER	I	RDS decoder CLK input terminal		
	NC		I	Not used		
18	LX_REQ_S	LX_M	I	Communication request from slave unit		
19	PON_AM	TUNER	O	AM power supply control		AM operation : H, Non-AM operation : L
20	MUTE_LEVEL	EXTRA	O	LEVEL_METER MUTE terminal		Mute ON : H, Mute OFF : L
21	TUN_IFC_OUT	TUNER	I	F/E IFC OUT input terminal		H : Station detect, L : No detect
22	RDS_AFS_L	TUNER	I/O	Constant switching at noise detect	④	Refer to truth value table.
23	RDS_AFS_M	TUNER	I/O	Constant switching at noise detect	④	Refer to truth value table.
24	RDS_QUAL	TUNER	I	RDS decoder QUAL input terminal		
	NC		I	Not used		
25	RDS_DATA	TUNER	I	RDS decoder DATA input terminal		
	NC		I	Not used		
26	PWIC_BEEP	PWIC	O	Beep output		
27	TUN_SCL	TUNER	I/O	F/E I2C clock output terminal		(MAX 400kHz)
28	TUN_SDA	TUNER	I/O	F/E I2C data input/output terminal		
29	PAN_DATA	to PANEL	I/O	Between-panel communication (Bi-directional)		
30	PAN_CLK	to PANEL	I/O	Between-panel communication clock		
31	PAN_SCREQ	to PANEL	I/O	Between-panel communication request terminal (Used also for PN_DET)		
32	PAN_PNREQ	to PANEL	I	Between-panel communication request terminal		
33	AUD_SDA	AUDIO	I/O	E-VOL I2C data input/output terminal		
	CD_SDA	CD	I/O	CD mechanism I2C data input/output terminal		
34	AUD_SCL	AUDIO	I/O	E-VOL I2C clock output terminal		
	CD_SCL	CD	I/O	CD mechanism I2C clock output terminal		
35	PON_PAN	Power supply	I/O	Panel 5V control terminal		ON : H, Momentary power down, Panel come off and 11 minutes after ACC_OFF : Hi-Z
36	DSI	EXTRA	I/O	(D) SI control terminal		OFF : Hi-Z, Panel come off : Pulse driven, ILL_ON and OPEN (Power_ON) : H

MICROCOMPUTER'S TERMINAL DESCRIPTION

Pin No.	Pin Name	Module	I/O	Application	Truth Value Table	Processing Operation Description
37	PM_MOT1	P-MECHA	O	Panel motor control 1	②	Refer to truth value table.
38	PM_MOT2	P-MECHA	O	Panel motor control 2	②	Refer to truth value table.
39	EPM		I	FLASH EPM input terminal		
40	PM_OPEN	P-MECHA	I	Panel full open detect	③	Refer to truth value table.
41	PM_CLOSE	P-MECHA	I	Panel mechanism close detect	③	Refer to truth value table.
42	PAN_RST	to PANEL	O	Panel μ com reset output		Normal : H, Reset, Momentary power down, Panel is detached and 11 minutes after ACC_OFF : L
43	PM_DET	P-MECHA	I	Panel mechanism detect		H : Function check
44	SC_CON	to PANEL	O	Between panel Communication control (FLASH CE)		POWER OFF, ACC OFF : L
45	CD_DISC12_SW	CD	I	CD detect terminal (12cm)		
46	CD_LOS_SW	CD	I	CD loading detect terminal		
47	CD_MUTE_R	CD	I	CD MUTE (Rch) request terminal		L : Rch mute request
48	CD_MUTE_L	CD	I	CD MUTE (Lch) request terminal		L : Lch mute request
49	CD_MRST	CD	O	CD mechanism μ com RST terminal		H : Normal, L : Reset
50	CD_MSTOP	CD	O	CD mechanism μ com stop terminal		H : Mechanism μ com operation, L : Mechanism μ com stop
51	CD_DISC8_SW	CD	I	CD detect terminal (8cm)		
52	CD_LOE_LIM_SW	CD	I	CD detect terminal (chucking SW)		H : Loading complete, L : No disk
53	CD_LOEJ	CD	I/O	CD motor control terminal	⑧	Refer to truth value table.
54	CD_MOTOR	CD	O	CD motor control terminal	⑧	Refer to truth value table.
55	TUN_TYPE1	TUNER	I	Destination setting 1	⑤	Refer to truth value table.
56	TUN_TYPE0	TUNER	I	Destination setting 0	⑤	Refer to truth value table.
57	PON_ILL	Power supply	I/O	Key ILL power supply control		ON : H, OFF : Hi-Z
58	PON_CD	CD	O	CD WMA power supply control terminal		CD : L, Other than CD : H, When RESET, quicker than M-STOP L, Normal CD : NC
59	PON	Power supply	I/O	Power supply control		Power ON : H, Power OFF : Hi-Z
60	VCC2		-			
61	COR_DET	TYPE	I	E2PROM write request		H : Write
62	VSS		-			
63-65	TYPE_0~TYPE_2	TYPE	I	Destination switching	⑥	Refer to truth value table.
66	NC		O	Not used		Output : L
	LW_SW2	EXTRA	O	FL+B current control terminal at LW		DIMMER_ON : H, OFF : L, When DIMMER_ON from the beginning, ON before MUTE is turned OFF after PON stabilizes. E-Type only.
67	NC		O	Not used		Output : L
	LW_SW	EXTRA	O	FL+B current control terminal at LW		LW mode 153kHz~249kHz : H, 250kHz~281kHz : L MW and other sources : L, During seek, condition before seek, and after seek_stop, change is made. E-Type only.
68	OPEL_DATA	EXTRA	I/O	External display DATA		External display
69	OPEL_CLK	EXTRA	I/O	External display CLK		External display

MICROCOMPUTER'S TERMINAL DESCRIPTION

Pin No.	Pin Name	Module	I/O	Application	Truth Value Table	Processing Operation Description
70	OPEL_CE	EXTRA	I/O	External display control request		External display
71	EXT_CONT	EXTRA	O	External amp control		
72	P_CON	Power supply	I/O	External amp control terminal		Power ON : H, Power OFF : Hi-Z, All OFF : Hi-Z
73	ANT_CONT	TUNER	O	Power antenna control		Tuner ON : H
74	ILLMI_DET	EXTRA	I	Dimmer ILL detect		L : ON, H : OFF
75	BU_DET	Power supply	I	Momentary power down detect		BU detect : L, BU no detect and Momentary power down : H
76	ACC_DET	Power supply	I	ACC Power supply detect		ACC detect : L, ACC no detect : H
77	(PWIC_SVR)	PWIC	O	SVR electrical discharge circuit		Power OFF and Momentary power down, for 5s : H and then L
78	PWIC_MUTE	PWIC	O	Power IC MUTE terminal		All OFF and Momentary power down : L, TEL mute : L
79	PWIC_STBY	PWIC	O	Power IC standby control		Power ON : H, Power OFF : L
80	LX_CON	LX_M	O	Startup request to slave unit		H : Slave unit ON, L : Slave unit OFF
81	RESET2		O	MUTE terminal for reset		Output : L
82	MUTE	AUDIO	O	MUTE terminal		ON : H, OFF : L
83	MUTE_ACOUT	AUDIO	I/O	IC2 ACOUT MUTE		Muting of CD, MD and LXBUS
84	MUTE_SUBOUT	AUDIO	I/O	IC2 SUBOUT MUTE		Muting of CD, MD and LXBUS in 2 zones
85	MUTE_PRE_R	AUDIO	I/O	PRE_OUT MUTE Rch		M MUTE R is L : L (CD), Momentary power down : L, Only in 2 zones and NAVI interruption, Hi-Z fixed.
86	MUTE_PRE_L	AUDIO	I/O	PRE_OUT MUTE Lch		M MUTE R is L : L (CD), Momentary power down : L, Only in 2 zones and NAVI interruption, Hi-Z fixed.
87	LINE_MUTE	EXTRA	I	Line MUTE detect		TEL mute : 1V or less, NAVI mute : 2.5V or more, 1V or less and 2.5V or more : NAVI mute (J-type)
88	NC		O	Not used		Output : L
89	PWIC_DC_DET	PWIC	I	DC offset detect terminal		
90	LX_RST	LX_M	O	Hard reset to slave unit		H : Reset, L : Normal
91	LX_MUTE	LX_M	I	Mute request from slave unit		H : Mute ON, L : Mute OFF
92	LX_REQ_M	LX_M	O	Communication request to slave unit		
93	RDS_NOISE	TUNER	I	FM noise detect terminal		
94	AVSS		-			
95	TUN_SMETER	TUNER	I	S-meter input		
96	VREF		I	Analog reference potential		PON is input
97	AVCC		-			
98	LX_DATA_S	LX_M	I	Data from slave unit		
99	LX_DATA_M	LX_M	O	Data to slave unit		
100	LX_CLK	LX_M	I/O	LX BUS clock		

MICROCOMPUTER'S TERMINAL DESCRIPTION

● Truth Value Table

② Panel Motor Control

	OPEN	CLOSE	STOP	WAIT
PM_MOT1	L	H	H	L
PM_MOT2	H	L	H	L

③ Panel Mechanism Control

	FULL_OPEN	FULL_CLOSE	OTHER
PM_OPEN	H	L	L
PM_CLOSE	H	L	H

④ AFS Control

	RDS_AFS_M	RDS_AFS_L	Condition
AFS LOW	L	L	No sound output in AF search
AFS MID	L	Hi-Z	Sound output in AF search
AFS HIGH	Hi-Z	Hi-Z	Normal Reception

⑤ Tuner Type

	TUN_TYPE1 (55 pin)	TUN_TYPE0 (56 pin)
Market Model	L	L
OEM Model 1	L	H
OEM Model 2	H	L
OEM Model 3	H	H

⑥ 30624MGPA27GP

TYPE_2 (65 pin)	TYPE_1 (64 pin)	TYPE_0 (63 pin)	Model Name		Media
0	0	0	KDC-MP625	K	WMA/MP3
0	0	1	KDC-W6527/Y	E	WMA/MP3
0	1	0	KDC-X679	K	WMA/MP3
0	1	1	KDC-MP858	M	WMA/MP3
1	0	0	f-CD07	J	WMA/MP3
1	0	1	KDC-MP6025	K	WMA/MP3
1	1	0	KMD-6527	E	MD
1	1	1	f-MD07	J	MD

⑦ E's Light Truth Value Table

	E's-SW (16 pin)	E's1(67 pin)	E's2 (66 pin)
WOW-ON FLAT	L	Hi-Z	Hi-Z
WOW-OFF FLAT	H	Hi-Z	L
E's Light 100Hz	H	Hi-Z	Hi-Z
E's Light 125Hz	H	L	Hi-Z
E's Light 170Hz	H	Hi-Z	L

⑧ CD_MOTOR, CD_LOEJ

	CD_MOTOR	CD_LOEJ
Stop	L	Hi-z
Load	H	L
Eject	H	H
Brake	H	Hi-z
Use Prohibited	L	L

MICROCOMPUTER'S TERMINAL DESCRIPTION

● PANEL MICROCOMPUTER : 30622MWP111GP (X16-251 : IC1)

Pin No.	Pin Name	Module	I/O	Application	Processing Operation Description
1	NC		O	Not used	Output : L
2	REMO	REMO	I	Remote control signal input	Pulse width DET
3	GSO0	FL	O	FL dot section data output terminal 0	Data output
4	NC		O	Not used	Output : L
5	GCLK0	FL	O	FL dot section clock output terminal 0	2.0MHz
6	BYTE	μcom	-	Not used	0V GND direct connection
7	CNVSS	μcom	-	Used when rewriting μcom	
8,9	NC		O	Not used	Output : L
10	RESET	μcom	-	Reset terminal	L : Reset
11	XOUT	μcom	-	Clock output	
12	VSS	μcom	-	GND terminal	
13	XIN	μcom	-	Clock input	10.000MHz
14	VCC1	μcom	-	Positive power supply terminal	
15	NMI		I	Not used	
16	SOURCE	KEY	I	Source key input	H : ON, L : OFF
17	EJECT	KEY	I	Eject key input	H : ON, L : OFF
18	SCCON	to SYS	I	System μcom communication panel operation control	H : Operation
19	NC		O	Not used	Output : L
20	GCP	FL	O	FL dot section gradation occurrence	Gradation occurrence
21	NC		O	Not used	Output : L
22	GLAT	FL	O	FL dot section data latch output	Data latch output
23	NC		O	Not used	Output : L
24	GBK	FL	O	FL dot section data blanking output	H : Light ON, L : Light OFF
25,26	NC		O	Not used	Output : L
27	SCL		O	E2PROM write clock terminal	When E2P_DET is H : Input, Other : I2C clock output terminal
28	SDA		O	E2PROM write terminal	When E2P_DET is H : Input, Other : I2C data output terminal
29	PN_SDA	to SYS	I/O	System μcom communication data input/output terminal	
30	PN_SCL	to SYS	I/O	System μcom communication clock input/output terminal	100kHz
31	SC_REQ	to SYS	I	Panel communication request input	
32	PN_REQ	to SYS	O	Panel communication request output	L : Transmitting panel side data
33	GSO1	FL	O	FL dot section data output terminal 1	Data output
34	NC		O	Not used	Output : L
35	GCLK1	FL	I	FL dot section clock input terminal	GCLK0 input
36	E2P_DET		I	E2PROM write request	H : Write
37,38	NC		O	Not used	Output : L
39	EPM		I	Used when rewriting μcom	
40~43	NC		O	Not used	Output : L

MICROCOMPUTER'S TERMINAL DESCRIPTION

Pin No.	Pin Name	Module	I/O	Application	Processing Operation Description
44	CE		I	Used when rewriting μ com	
45~49	NC		O	Not used	Output : L
50	PON_DC_DC	Power supply	I/O	DC/DC control terminal	H : FL+B ON, Hi-Z : FL+B OFF
51	BLUE_LED	Power supply	I/O	ILL BLUE ON/OFF	Hi-Z : Light OFF, L : Light ON
52	NC		O	Not used	Output : L
53	PON	Power supply	I/O	Power supply control terminal	L : ON, Hi-Z : OFF
54	FL_VDD_ON	Power supply	O	FL3.3V Power supply control request	H : ON
55~59	NC		O	Not used	Output : L
60	VCC2	μ com	-	Positive power supply terminal	
61	NC		O	Not used	Output : L
62	VSS	μ com	-	GND terminal	
63~72	NC		O	Not used	Output : L
73	ATT_KEY	KEY	I	ATT key input	H : OFF, L : ON
74	VOL_A	KEY	I	VOL key input	Pulse width DET
75	VOL_B	KEY	I	VOL key input	Pulse width DET
76,77	NC		O	Not used	Output : L
78	RED_LED	Power supply	I/O	ILL RED ON/OFF	Hi-Z : Light OFF, L : Light ON
79	GREEN_LED	Power supply	I/O	ILL_GREEN ON/OFF	Hi-Z : Light OFF, L : Light ON
80	TRIANGLE_LED	Power supply	O	ILL TRIANGLE ON/OFF	L : Light OFF, H : Light ON
81,82	NC		O	Not used	Output : L
83	KS3	KEY	I/O	Key scan output 3	Output Low, Hi-Z switching
84	KS2	KEY	I/O	Key scan output 2	Output Low, Hi-Z switching
85	KS1	KEY	I/O	Key scan output 1	Output Low, Hi-Z switching
86	KS0	KEY	I/O	Key scan output 0	Output Low, Hi-Z switching
87	KR3	KEY	I	Key return input 3	
88	KR2	KEY	I	Key return input 2	
89	KR1	KEY	I	Key return input 1	
90	KR0	KEY	I	Key return input 0	
91	NC		O	Not used	Output : L
92	LEVEL_METER	EXTRA	I	LEVEL_METER input terminal	
93	NC		O	Not used	Output : L
94	AVSS	μ com	-	GND terminal	
95	VREF_CONT	μ com	O	VREF control terminal	H : ON
96	VREF	μ com	I	Analog reference voltage	
97	AVCC	μ com	-	Positive power supply terminal	
98~100	NC		O	Not used	Output : L

TEST MODE

● How to enter the Test Mode

Reset while pressing both [1] key and [3] key.

● How to release the Test Mode

The Test Mode can be released by resetting. The Test Mode is also released when there are: a momentary power down, Acc OFF, power OFF, and panel detachment.

● Initial condition of the Test Mode

The following are initial conditions of the Test Mode:

- The source in standby mode.
- The displays all lit up.
- Volume is -10dB (display will be 30).
- LOUD is OFF.
- CRSC is OFF regardless of whether the switching function is effective or not.
- SYSTEM Q is in NATURAL.
- SRS WOW are all OFF.
- BEEP will be a short one at all times.
- AUX is ON.
- SYSTEM Q on the MENU is OFF.
- GUIDE (NAVI) on the MENU is ATT.
- DISPLAY TYPE is TYPE A.

● RDS Automatic Measurement

Conventionally, the visual inspection on the PS display has been conducted on the production line. From now on, a measure will be added to replace this.

PS data is received and the PS contents is confirmed to be "RDS_TEST", the P-CON terminal is forced to go OFF. ("_" means blank.)

This is a measure specific for the Test Mode.

P-CON is recovered by switching the source or by power OFF→ON.

● Special Display in the TUNER Mode

In the TUNER mode, there are abnormalities in the front end, etc. when the following displays are made.

- "TNE2P_NG": E2PROM is still in the initial value (unspecified value) due to F/E being shipped without going through the adjustment process or other reasons.
- "TNCON_NG": There is no communication with the F/E.

● Forced Switching of K3I

In TUNER mode, every time the [6] key is pressed, the following takes place: AUTO → Forced WIDE → Forced MIDDLE → Forced NARROW → AUTO. The initial condition is AUTO and there will be the following displays:

- AUTO : FMA
- Forced WIDE : FMW
- Forced MIDDLE : FMM
- Forced NARROW : FMN

Note : In synchronization with the above changes, numbers 1 through 3 are displayed but these are to be ignored.

● CD Receiver Test Mode Specifications

- With ►► key, there will be jumps to the following tracks:
No. 9 → No. 15 → No. 10 → No. 11 → No. 12 → No. 13 → No. 22 → No. 14 → No. 9 (Back to the beginning)
However, when playing MP3/WMA disks with 8 files or less, tracks will be played in sequence as usually, beginning with Track1.
- When ◀◀ key is pressed, the previous track from the current one will be played.
- While playing from CD sources, when [1] key is pressed intermittently, there will be a jump to No. 28.
- With models that have MP3 or MP3/WMA mechanism, the model name and version will be displayed in the lower column.
- When [6] key is pressed, there will be a jump to No. 15. When this takes place, the value is set to 29 (eXcelon model) or 26 (other models).

TEST MODE

● Audio Related Matters

- When [Q] key is pressed intermittently, audio adjust mode is entered.
- With [*] key on the remote controller, audio adjust mode is entered.
- The initial item is Fader.
- Continuous feed with the remote controller is prohibited.
- The Bass/Middle/Treble levels are adjusted using ◀◀ / ▶▶ keys on three levels: -8 ↔ 0 ↔ +8. (Initial value: 0)
- Balance is adjusted using ◀◀ / ▶▶ keys on three levels: L15 ↔ 0 ↔ R15. (Initial value: 0)
- Fader is adjusted using ◀◀ / ▶▶ keys on three levels: R15 ↔ 0 ↔ F15. (Initial value: 0)
- Sub Woofer level is adjusted using ◀◀ / ▶▶ keys on three levels: -15 ↔ 0 ↔ +15. (Initial value: 0)
- Volume Offset is adjusted using ◀◀ / ▶▶ keys on two levels: -8 ↔ 0. (Initial value: 0)
- HPF is adjusted using ◀◀ / ▶▶ keys on two levels: Through ↔ 170Hz (or 220Hz). (Initial value: Through)
- LPF is adjusted using ◀◀ / ▶▶ keys on two levels: 50Hz ↔ Through. (Initial value: Through)
- Bass f / Bass Q / Bass EXT / Middle f / Middle Q / Treble f is not displayed on Audio Adjust.
- [WOW] key feeding works in the following order: ① → ② → ③ → ④ → ⑤ → ⑥ → ①

Order	Value Setting			Display
	TruBass	FOCUS	SRS 3D	
①	OFF	OFF	OFF	SRS WOW OFF
②	ON	OFF	OFF	SRS TruBass ON
③	OFF	Low	OFF	FOCUS LOW
④	OFF	High	OFF	FOCUS HIGH
⑤	OFF	OFF	ON	SRS 3D ON
⑥	ON	High	ON	SRS WOW HIGH

● MENU Related Matters

- When [MENU] key is pressed intermittently, MENU is entered.
- Using [DNPP/SBF] key on the remote controller, MENU is entered.
- Continuous feed with the remote controller is prohibited.

● Backup Current Measurement

When reset in the Acc OFF (Back Up ON) condition, MUTE terminal goes off in 2 seconds instead of 15 seconds. (When this takes place, CD/MD mechanisms will not be in operation.)

● Special Display when All Lamps are Lighted Up

When all lamps are lighted up during STANDBY, the following displays will be made by pressing the pre-set key.

[1] key	Version Display (Display) SYS_x.xx PAN_x.xx
[2] key	Serial number display (8 digits) (Display) SNo_0xxxxxxx
[3] key	Single Push: Displays Power ON time During Power ON time display, pressing the key two (2) seconds will clear Power ON time. (Display) PonTim_0xxxxx MAX 65535 (Hours)
[4] key	Single Push: Hours CD/MD in operation. During CD/MD operation time display, pressing the key two (2) seconds will clear CD/MD operation time. (Display) CDTim_0xxxxx / MDTim_0xxxxx MAX 65535 (Hours)
[5] key	Single Push: Number of CD/MD EJECT times will be displayed. During CD/MD EJECT time display, pressing the key two (2) seconds will clear CD/MD EJECT times. (Display) EjeCnt_0xxxxx MAX 65535 (Times)
[6] key	Single Push: Number of PANEL open/close times (*1) During PANEL open/close times display, pressing the key two (2) seconds will clear PANEL open/close times. (Display) PnCnt_0xxxxx MAX 65535 (Times)
[FM] key	ROM Correction Version Display (Display) SYS_ROM_Rxxx When N/A: SYS_ROM_R --- (Display) PAN_ROM_Rxxx When N/A: PAN_ROM_R ---
▶▶ key	AUDIO data initial value setting (Display) AUDIO_INIT

*1 : One count is made when panel is full open or at disc loading.

TEST MODE

● Initializing AUDIO Related Value Settings

During STANDBY, by pressing ►► key intermittently, AUDIO setting values will reset to the default values of the Test Mode.

● Side Graphic Display (Level Meter)

In the Test Mode, regardless of the contents selected, the Side Graphic Display will be used as the dedicated display for making judgment on level input.

Normally, Side Display will be all off, when it is judged to be OK level with the FM standard input (1kHz/60dB), ">" and "<" will be displayed on both sides. (When it is judged to be NG, the display will remain all off.)

(OK level: E type (40k); 0.5~1.5V, For other than E type (75k); 1.5~3.5V)

● Others

- At Power ON, "CODE_OFF" and "CODE_ON" displays will not be made.
- When started up in the Test Mode, LINE MUTE prohibition time will be one second instead of ten.
- When in the Test Mode, security codes should not be written with the security jig.
- When in the Test Mode, serials should not be written with the security jig.
- When in the Test Mode, even if a DC error is detected, the detection information will not be written to the E2PROM.
- When in the Test Mode and, at the same time, PM_DET terminal is H, panel full open/close is achieved by intermittently pressing in the [EJECT] key, regardless of whether a disc is in the mechanism. (Protection time: 3 seconds) Whereas, ejection is achieved by pressing the [EJECT] key for one second.

● Clearing DC Error Detection Information (Clearing E2PROM data)

1. While pressing [3] key and [6] key, reset to enter the DC Error display mode.
2. In the display during STANDBY, the current DC Error condition is displayed.
When error is detected: "DC_ERR"
When error is not detected: "DC_OK"
3. While error condition is displayed, by pressing [AUTO] / [TI] / [WOW] keys intermittently, the detection information is cleared. (Clear E2PROM)
4. DC Error display mode is cleared by resetting. (The last display will not be maintained.)

● Frequency Spun Switching (K/M type)

While pressing [1] key and [5] key, turn power ON.

● Security

• Forced Power ON Mode (All models)

Even when the security is set, by resetting while pressing both [Q] key and [4] key, it is possible to turn the power on for 30 minutes only. Likewise, after the elapse of 30 minutes, the device must be reset to restart.

• How to Register Security Code after exchanging E2PROM (F/E) (Code Security Model)

1. Enter the Test Mode. (Refer to How to Enter the Test Mode.)
2. Enter MENU by pressing [MENU] key.
While "Security" is being displayed, press ◀◀ / ▶▶ keys for one second to enter the Security Registration mode.
3. Enter the code by pressing [FM] / [AM] / ◀◀ / ▶▶ keys.
FM key: Increment number / AM key: Decrement number
▶▶ key: Cursor to right / ◀◀ key: Cursor to left
4. Press ▶▶ key for three (3) seconds to display "RE-ENTER".
Then, enter the code as indicated in above item 4.
5. Press ▶▶ key for three (3) seconds to display "APPROVED".
6. Release the Test Mode. (Refer to: How to Release the Test Mode.)

Note: In this mode, the security code will be all cleared.

• Simplified Method to Clear Security Code (K type only)

1. While in the Code Request mode, press ▶▶ key for three seconds while pressing the [AUTO] key. (--- display goes off.)
2. Input "KCAR", using the remote controller.
Press [5] key twice, and then press ▶▶ key on the remote controller. (Enter "K".)
Press [2] key three (3) times, and then press ▶▶ key. (Enter "C".)
Press [2] key once, and then press ▶▶ key. (Enter "A".)
Press [7] key twice, and then press ▶▶ key. (Enter "R".)
3. Then the security is cleared and the STANDBY mode is entered.
4. When a wrong code is entered, the Code Request mode is entered.

PC BOARD (COMPONENT SIDE VIEW)

ELECTRIC UNIT X34-301x-xx/X34-3222-70 (J76-0025-22/J74-1577-02)

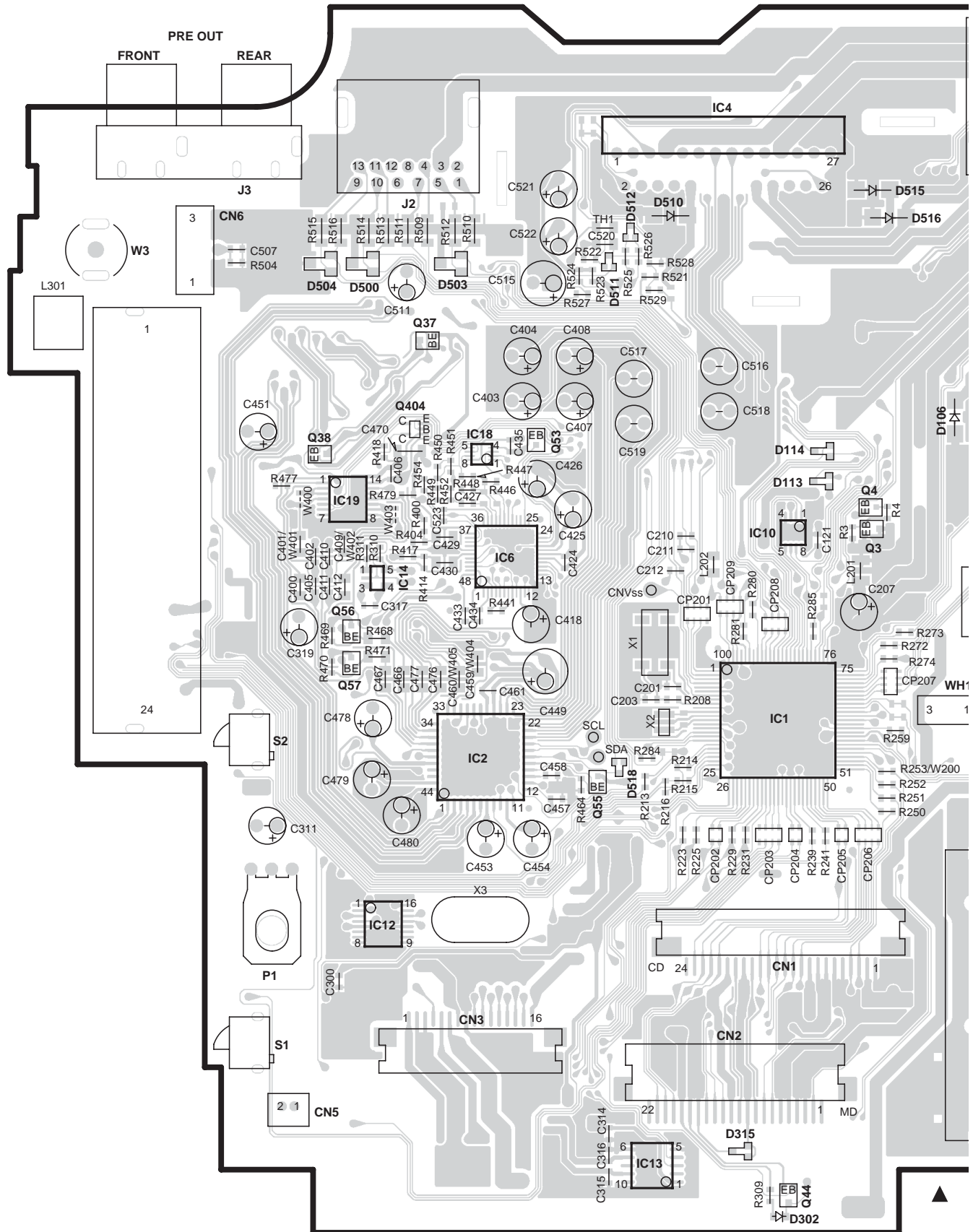

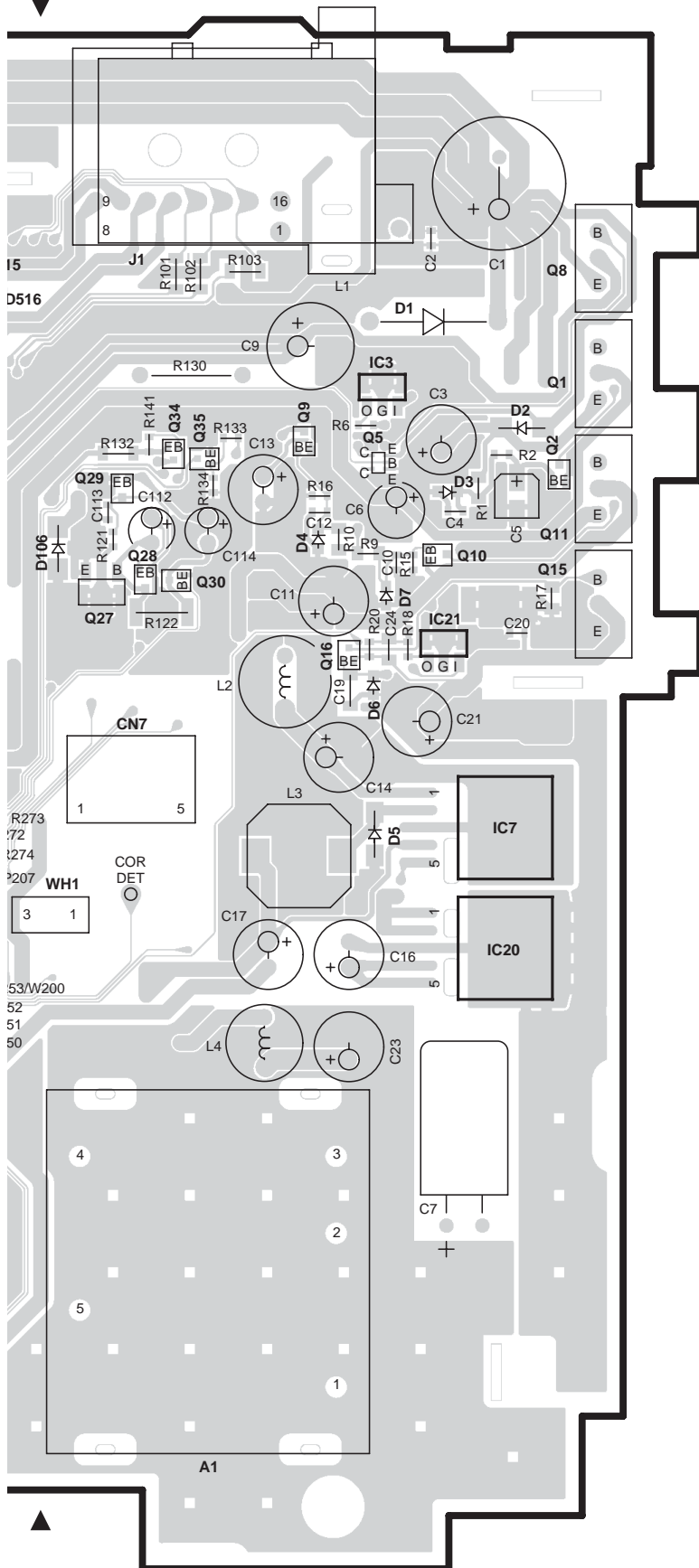

X34-301x-xx

X34-3222-70

Ref. No.	Address
IC1	5E
IC2	5C
IC3	3G
IC4	2D
IC7	4G
IC10	4E
IC12	6C
IC13	7D
IC14	4C
IC20	5G
Q1	3H
Q2	3H
Q3	4E
Q4	4E
Q5	3G
Q8	2H
Q9	3G
Q10	3G
Q11	3H
Q15	3H
Q16	4G
Q27	4F
Q28	3F
Q29	3F
Q30	3F
Q34	3F
Q35	3F
Q37	3C
Q38	3B
Q44	7E
Q55	5D
Q56	4C
Q57	5C

Refer to the schematic diagram for the values of resistors and capacitors.

KDC-MP6025/MP625/MP858
KDC-W6527/W6527Y

PC BOARD (FOIL SIDE VIEW)

ELECTRIC UNIT X34-301x-xx/X34-3222-70 (J76-0025-22/J74-1577-02)

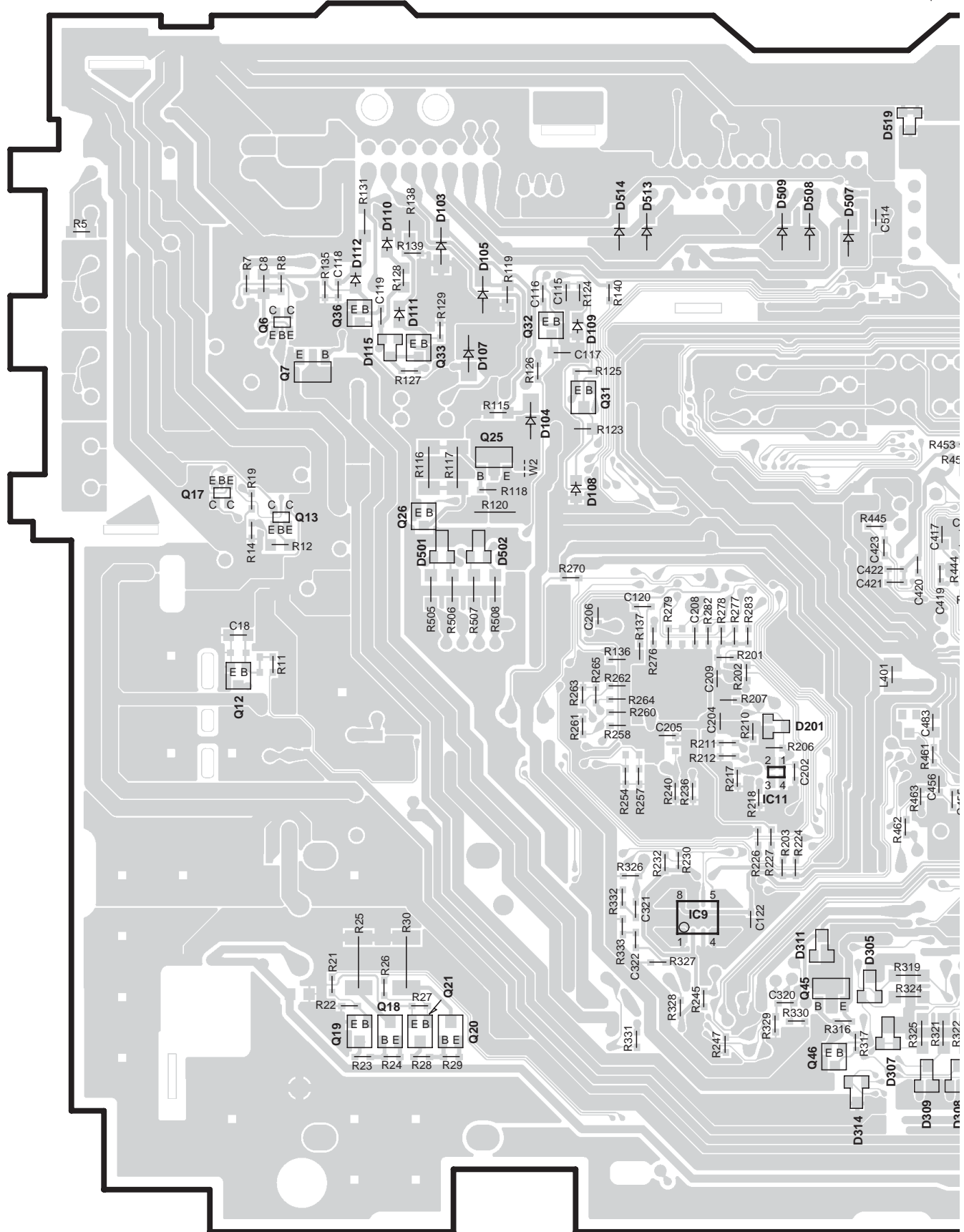

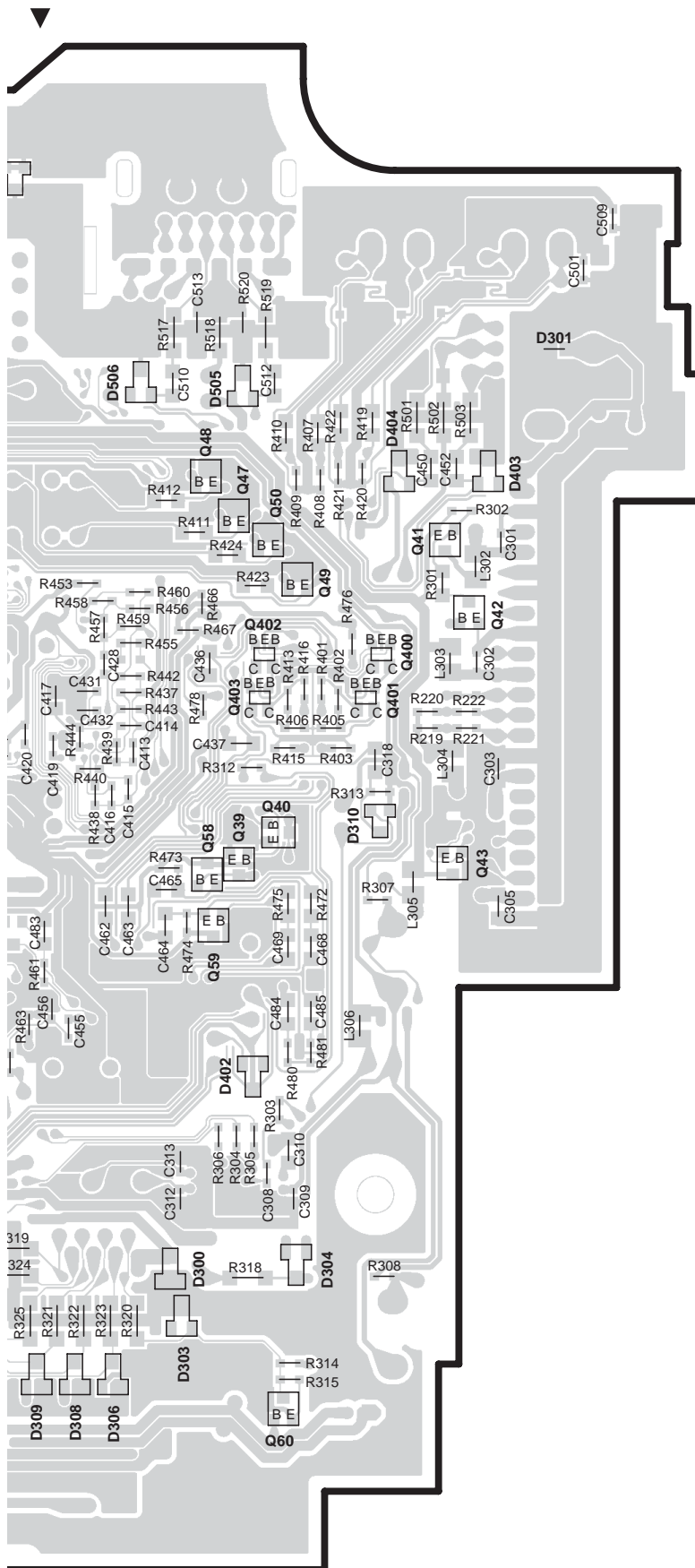

X34-301x-xx

X34-3222-70

Ref. No.	Address
IC11	50
Q6	3L
Q7	3L
Q12	5L
Q13	4L
Q25	3M
Q26	4M
Q31	3N
Q32	3M
Q33	3M
Q36	3M
Q39	4P
Q40	4Q
Q41	3Q
Q42	4Q
Q43	5Q
Q45	6O
Q46	6O
Q47	3P
Q48	3P
Q49	3Q
Q50	3Q
Q58	4P
Q59	5P
Q60	7Q

Refer to the schematic diagram for the values of resistors and capacitors.

PC BOARD (COMPONENT SIDE VIEW)

CD PLAYER UNIT X32-5500-00 (J74-1552-12)

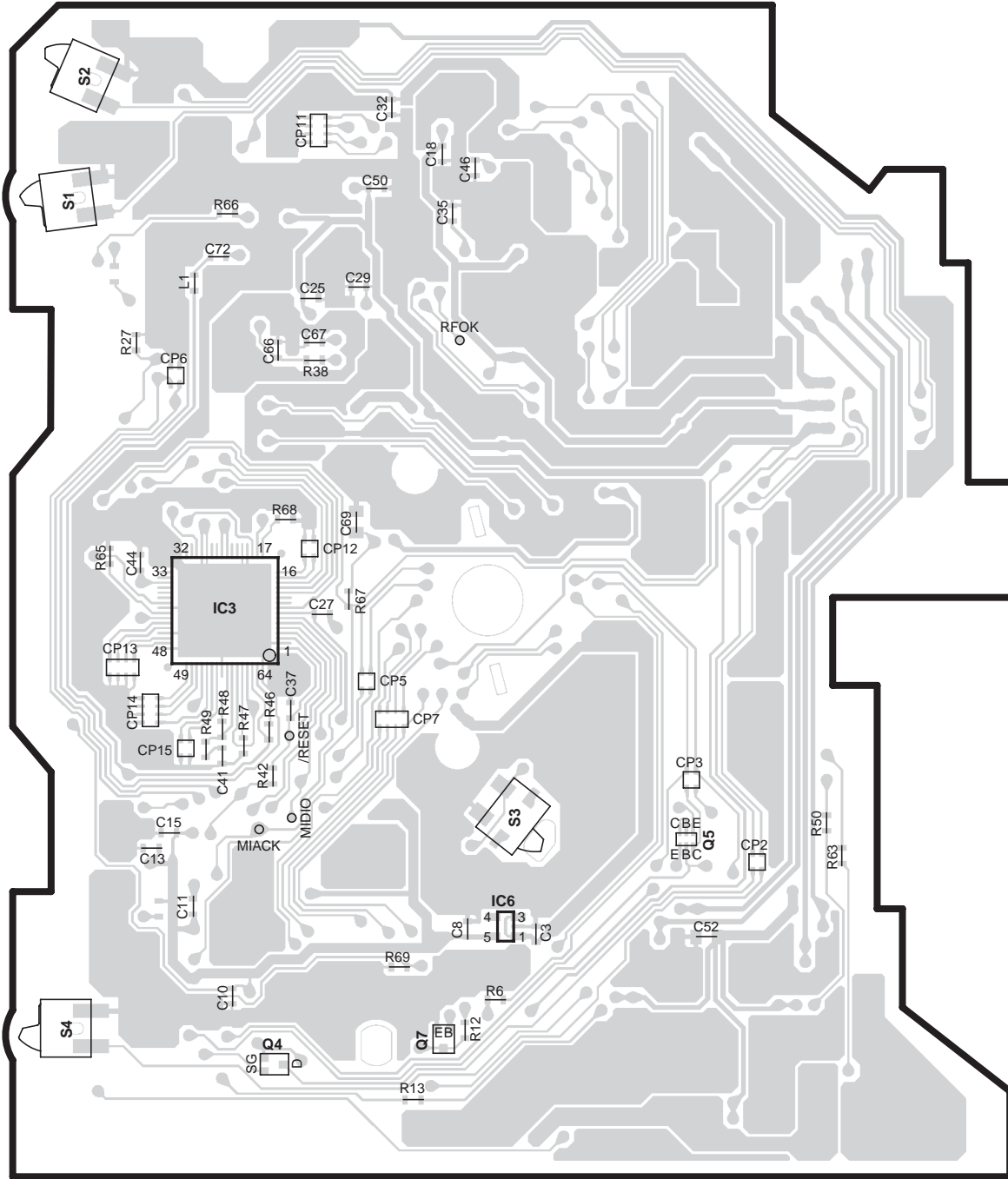

X32-5500-00

Ref. No.	Address
IC3	4V
IC6	5W
Q4	5V
Q5	5X
Q7	5W

Refer to the schematic diagram for the values of resistors and capacitors.

PC BOARD (FOIL SIDE VIEW)

CD PLAYER UNIT X32-5500-00 (J74-1552-12)

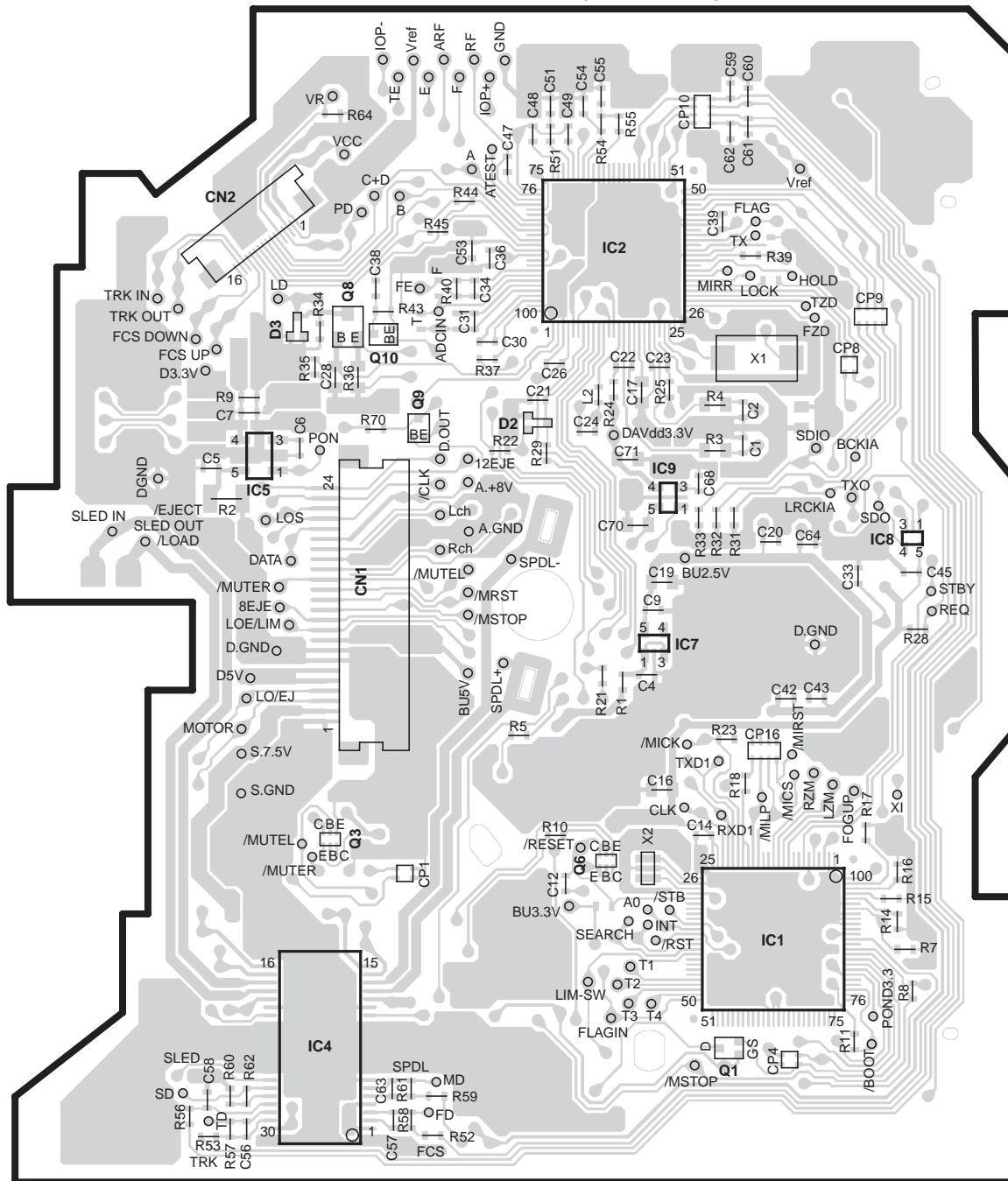

X32-5500-00

Ref. No.	Address	Ref. No.	Address
IC1	5AC	Q1	5AC
IC2	2AB	Q3	5AA
IC4	5AA	Q6	5AB
IC5	3AA	Q8	2AA
IC7	4AB	Q9	3AA
IC8	3AC	Q10	3AA
IC9	3AB		

Refer to the schematic diagram for the values of resistors and capacitors.

KDC-MP6025/MP625/MP858
KDC-W6527/W6527Y

PC BOARD (COMPONENT SIDE VIEW)

SUB-CIRCUIT UNIT
X16-2510-10 (J76-0026-22)
X16-2722-70 (J74-1574-02)

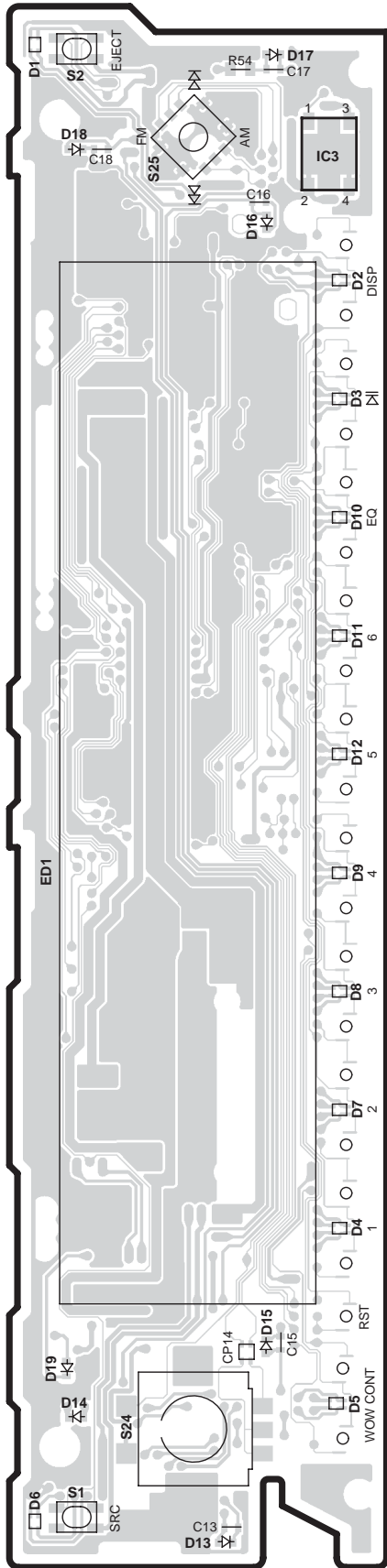

X16-2510-10
X16-2722-70

Ref. No.	Address
IC3	2AF

Refer to the schematic diagram for the values of resistors and capacitors.

(FOIL SIDE VIEW)

SUB-CIRCUIT UNIT
X16-2510-10 (J76-0026-22)
X16-2722-70 (J74-1574-02)

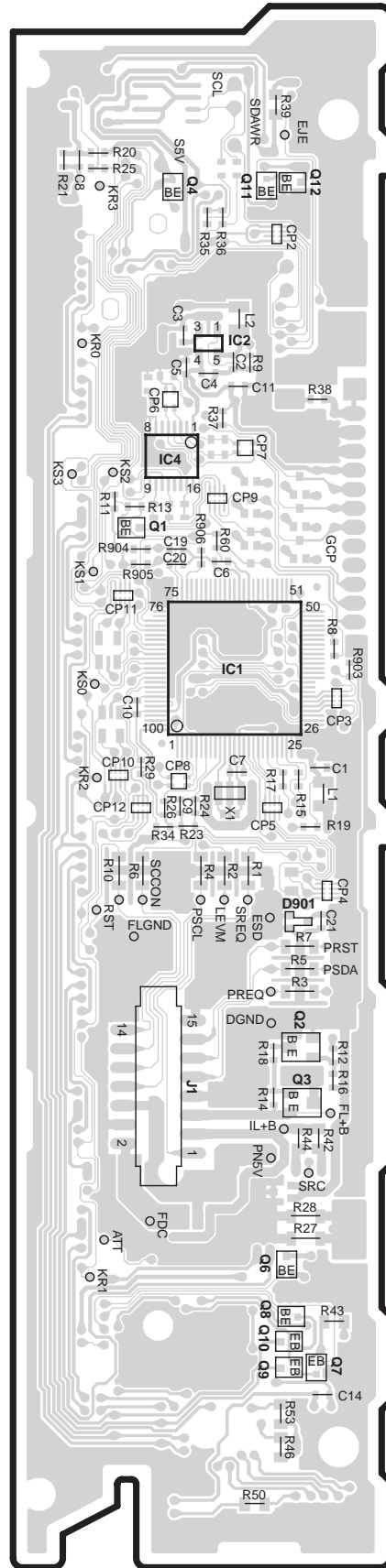

X16-2510-10
X16-2722-70

Ref. No.	Address
IC1	4AH
IC2	3AH
IC4	3AH
Q1	3AH
Q2	5AH
Q3	5AH
Q4	2AH
Q6	6AH
Q7	6AI
Q8	6AH
Q9	6AH
Q10	6AH
Q11	2AH
Q12	2AH

KDC-MP6025/MP625/MP858 KDC-W6527/W6527Y

1
2
3
4
5
6
7

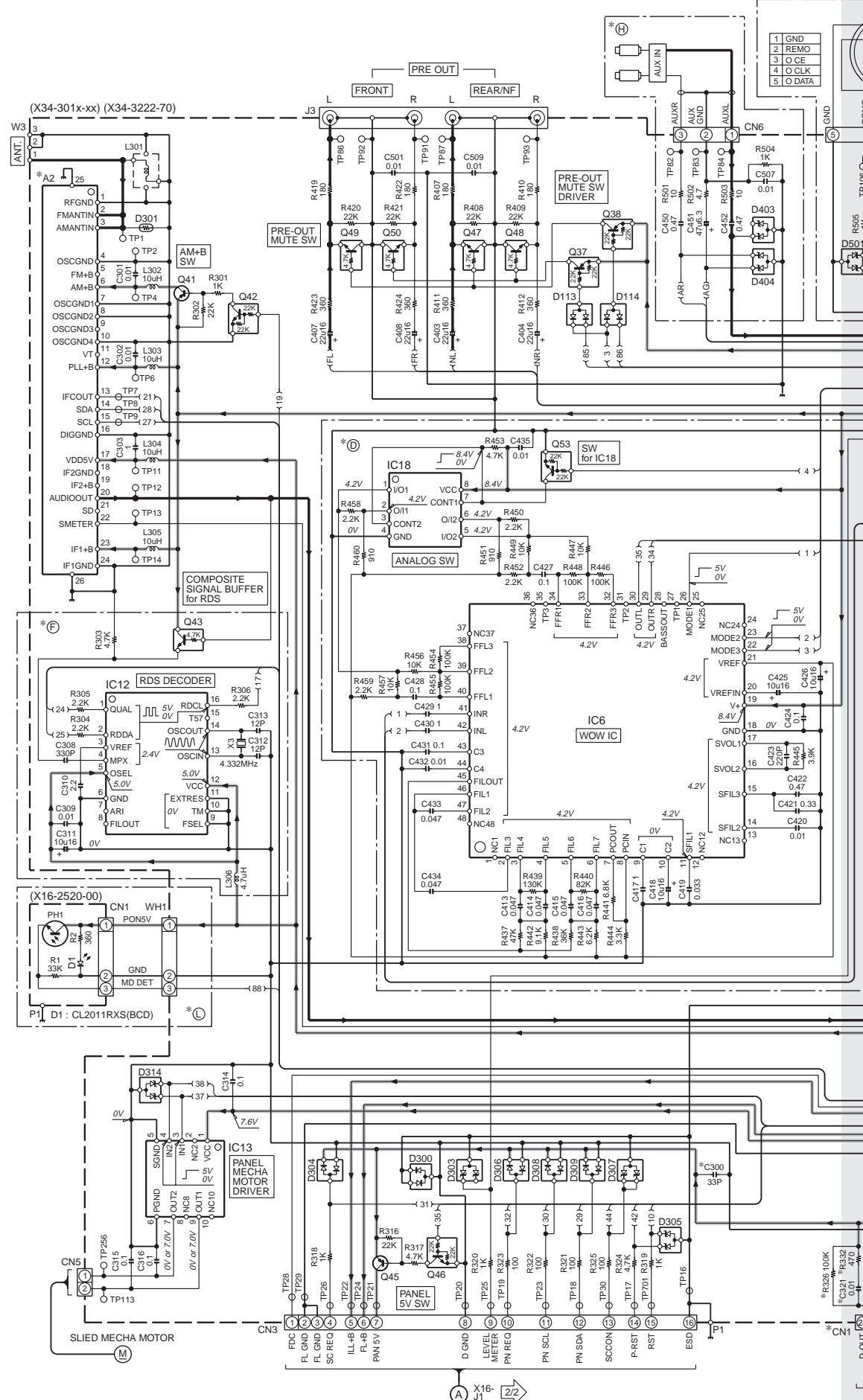

- 1 GND
- 2 REMO
- 3 O CE
- 4 O CLK
- 5 O DATA

KDC-MP6025/MP625/MP858 KDC-W6527/W6527Y

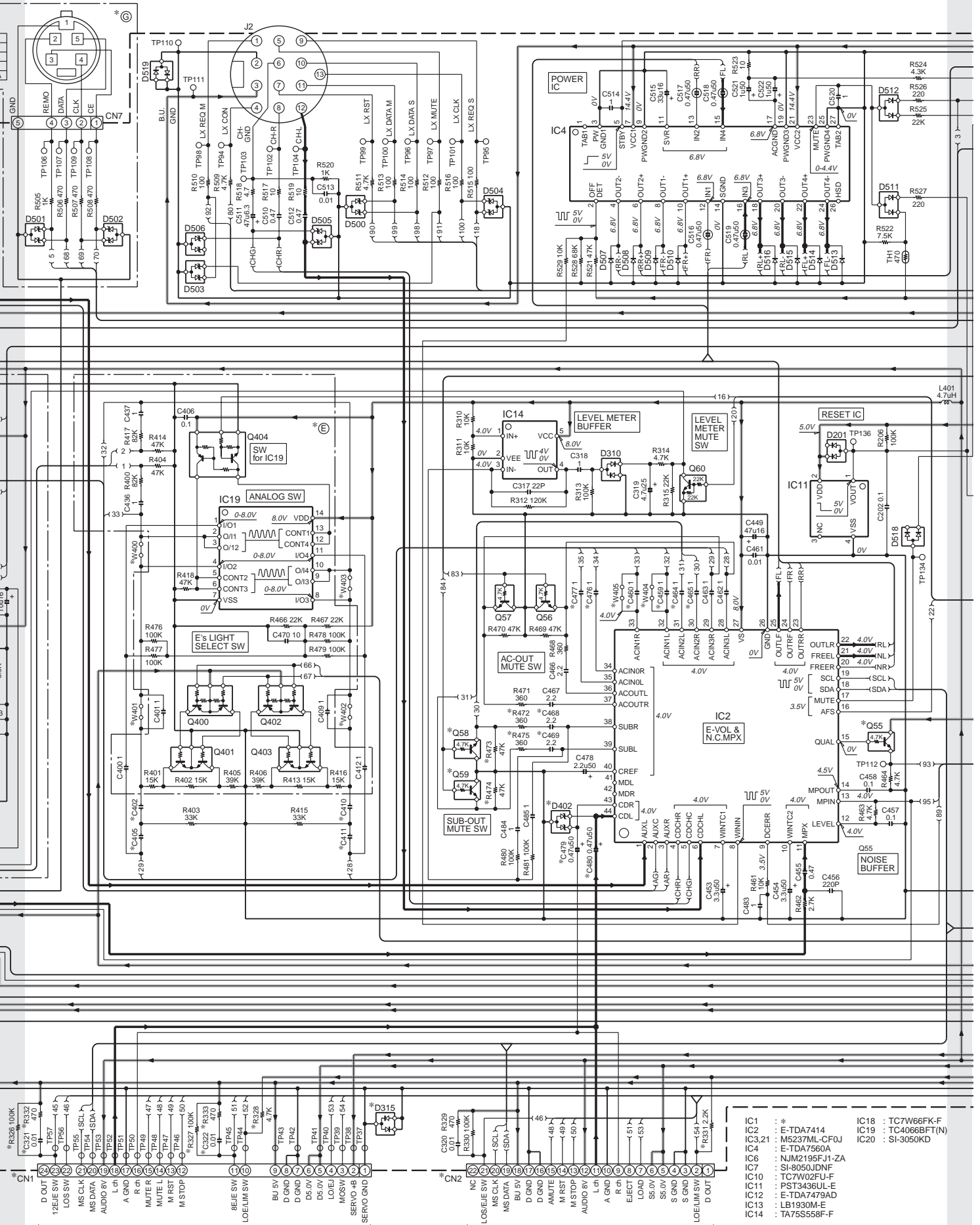

to CD MECHANISM ASSY (X32-5400-00/01) (X32-5500-00/01) (X32-5560-00)

to MD MECHANISM ASSY (X33-3180-00)

- IC1 : *
- IC2 : E-TDA7414
- IC3,21 : M5237ML-CF0J
- IC4 : E-TDA7560A
- IC5 : NUM2195FJ1-ZA
- IC6 : SI-805JDNF
- IC7 : SI-805JDNF
- IC8 : TC7W02FU-F
- IC9 : PST3436LU-E
- IC10 : TC7W02FU-F
- IC11 : PST3436LU-E
- IC12 : E-TDA7479AD
- IC13 : LB1930M-E
- IC14 : TA75558F-F
- IC18 : TC7W66FK-F
- IC19 : TC4066BFT(N)
- IC20 : SI-3050KD

KDC-MP6025/MP625/MP858 KDC-W6527/W6527Y

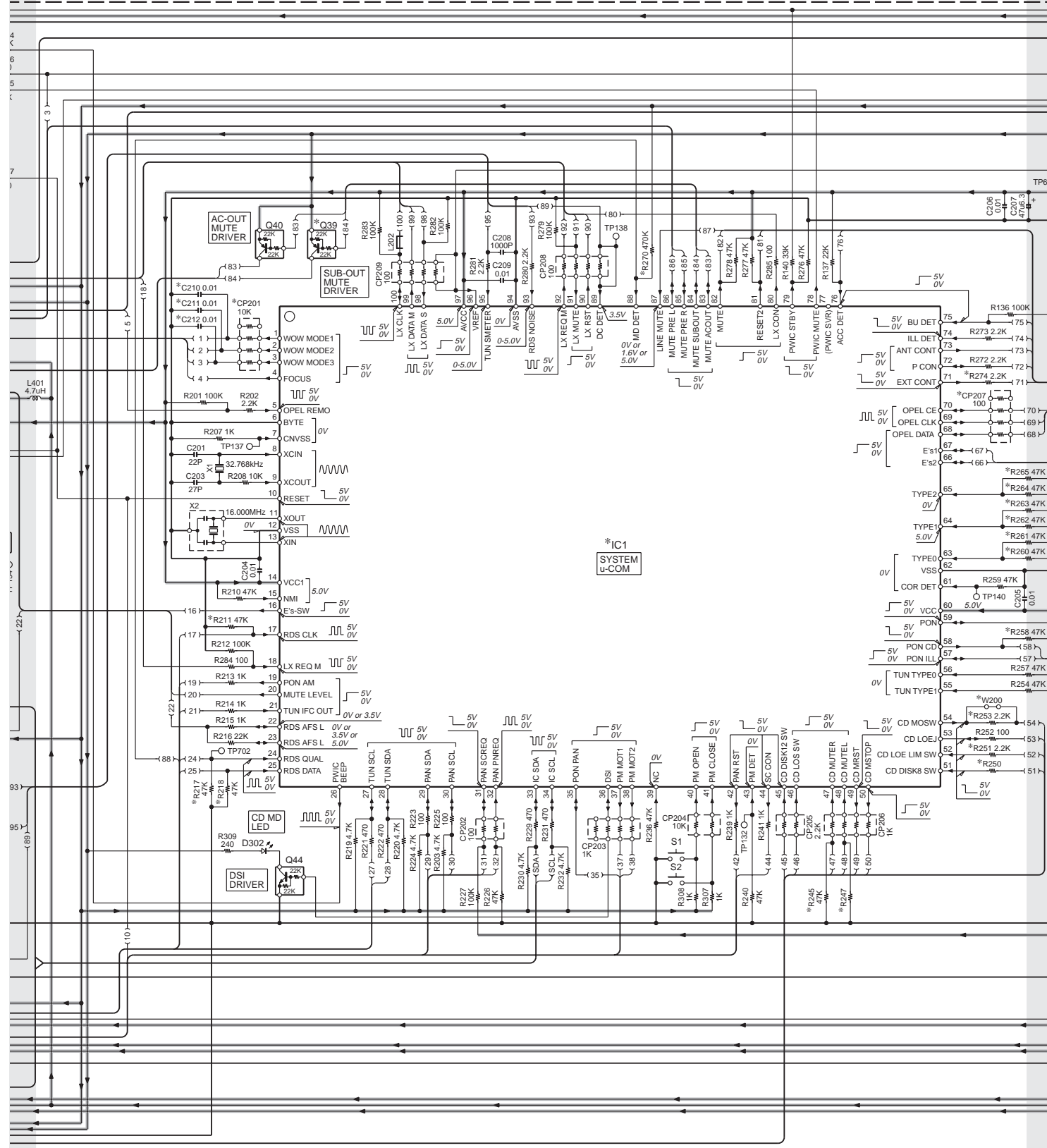

FK-F	Q1,8,11,15 : 2SB1565	Q19,21 : 2SC2713-F	Q43,47-50,58,59	D1 : S2V60*A	D113,114,201 : DAP202U
IFT(N)	Q2,9,10,33,36	Q25,27 : 2SB1188(Q,R)	Q55-57 : DTC143TUA	D2 : RB160L-40	D115 : DAN202U
ID	Q3,28,41 : 2SC4081	Q26 : DTC114YUA	Q400,402 : UMA2N	D3,108 : UDZS5.6B	D300,304,306,308,309
	Q4,53 : 2SA1576A	Q29 : DTA114EUA	Q401,403 : UMG3N	D4 : UDZS8.2B	D301 : DA204K
	Q5,6,13,17,404	Q30 : PDTC114YE or DTC114YE		D5 : SFPB-54VNF	D302 : IMSA-6801-E
	Q7,45 : 2SB1188(R)	Q31 : DTA123JK		D6 : HZU11(B1)-E	D303,305,307,500-504
	Q12,32 : DTC144EUA	Q34 : 2SA1774		D7 : HZU9.1(B1)-E	D310,315,519 : DA204U
	Q16,35 : 2SC4617	Q37-40 : DTA124EUA		D103-107,507-510, 513-516 : 1SR154-400	D314,402-404,505,506
	Q18,20 : 2SA1163-F	Q42,44,46,60		D109 : UDZS4.7B	D511,512,518 : DAP222
		Q42,44,46,60 : DTC124EUA		D110,111 : UDZS6.8B	
				D112 : UDZS6.2B	

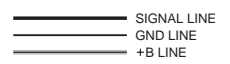

P Q R S T
KDC-MP6025/MP625/MP858
KDC-W6527/W6527Y

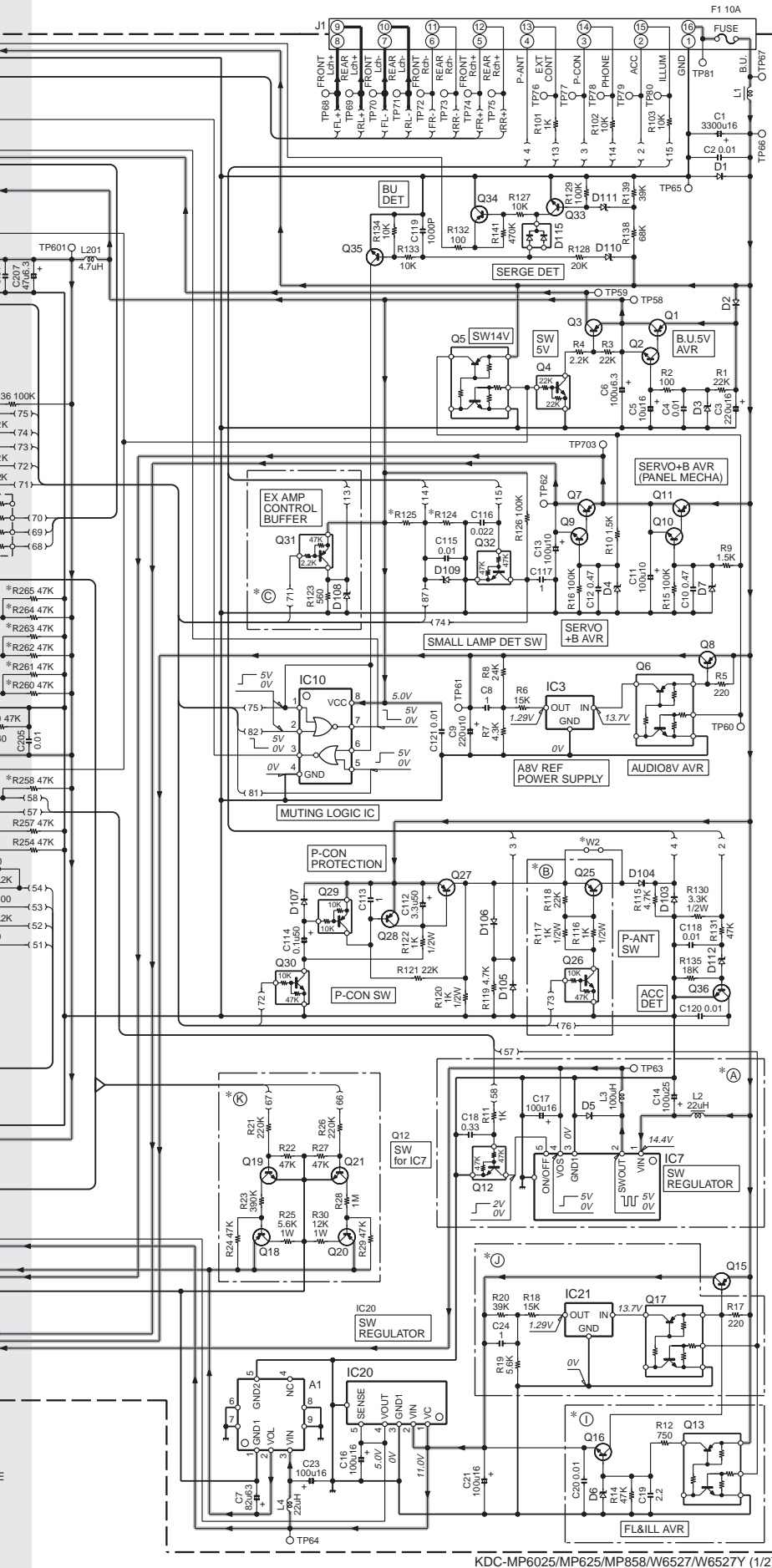

KDC-MP6025/MP625/MP858/W6527/W6527Y (1/2)

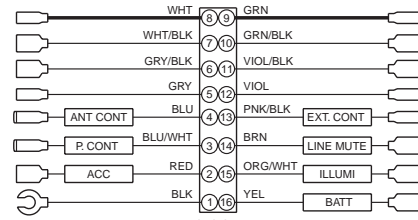

DC CORD
 (E30-6028) : F-CD07/05/05S
 F-MD07

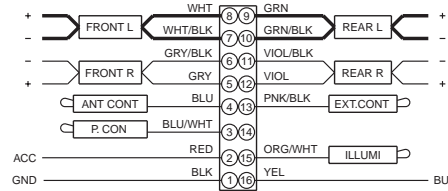

DC CORD
 (E30-6294) : KDC-MP858
 KDC-757

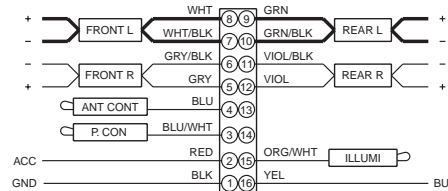

DC CORD
 (E30-6295) : KDC-MP625
 KDC-MP6025

CAUTION : For continued safety, replace safety critical components only with manufacturer's recommended parts (refer to parts list).

⚠ Indicates safety critical components. To reduce the risk of electric shock, leakage-current or resistance measurements shall be carried out (exposed parts are acceptably insulated from the supply circuit) before the appliance is returned to the customer.

- DC voltages are as measured with a high impedance voltmeter. Values may vary slightly due to variations between individual instruments or/and units.

KDC-MP6025/MP625/MP858 KDC-W6527/W6527Y

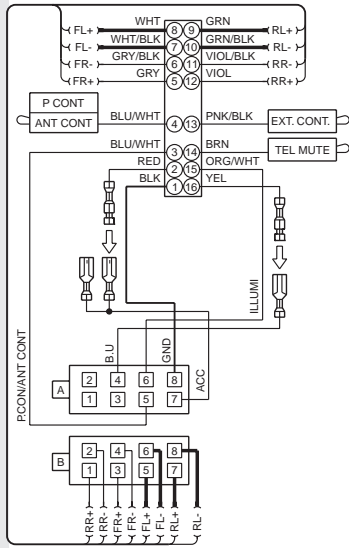

DC CORD
(E30-6063) : KDC-W6527/Y
KMD-6527

(X34-3xxx-xx)

MODEL NAME	UNIT No.	A	B	I	C	D	E	F	J	K	G	H	L	A2	C210-212,459,460,476,477	C300	C321	C322	C402,405,410,411	C464,465,468,469
KDC-MP625	X34-3010-10	YES	YES	NO	NO	NO	NO	NO	YES	NO	NO	NO	NO	X86-3760-11	NO	NO	YES	NO	0.1	NO
KDC-MP625	X34-3010-11	YES	YES	NO	NO	NO	NO	NO	YES	YES	NO	NO	NO	X86-3760-11	NO	NO	YES	NO	0.1	YES
KDC-MP858	X34-3010-21	YES	YES	YES	NO	NO	NO	NO	NO	NO	YES	NO	NO	X86-3760-11	NO	NO	YES	NO	0.1	YES
KDC-757	X34-3010-22	NO	YES	YES	NO	NO	NO	NO	NO	NO	YES	NO	NO	X86-3760-11	NO	NO	YES	NO	0.1	YES
KDC-W6527Y	X34-3012-71	YES	NO	YES	NO	YES	YES	YES	YES	YES	YES	YES	YES	X86-3762-70	NO	NO	YES	NO	0.1	YES
KMD-6527	X34-3012-72	YES	NO	YES	NO	YES	NO	YES	YES	YES	YES	YES	YES	X86-3762-70	NO	NO	NO	YES	0.1	YES
I-CD07	X34-3010-01	YES	YES	YES	YES	NO	NO	NO	NO	NO	NO	NO	NO	X86-3760-01	YES	YES	YES	NO	0.22	YES
I-CD05/05S	X34-3010-02	NO	YES	YES	NO	NO	NO	NO	NO	NO	NO	NO	NO	X86-3760-01	NO	YES	YES	NO	0.1	YES
I-MD07	X34-3010-03	YES	YES	YES	YES	YES	NO	NO	NO	NO	YES	YES	YES	X86-3760-01	YES	YES	NO	YES	0.22	YES
KDC-W6527	X34-3222-70	YES	NO	YES	NO	YES	NO	YES	YES	YES	YES	NO	NO	X86-3762-71	NO	NO	YES	NO	0.1	YES

UNIT No.	C479,480	CN1	CN2	CP201	CP207	D315	D402	IC1	Q39,58,59	Q55	R124	R125	R211,217,218	R245,251,253,326-328,332	R247	R250
X34-3010-10	CD04AS1HR47M(7)	YES	NO	NO	YES	YES	NO	30624MGPA27GP	NO	NO	22K	47K	YES	YES	47K	2.2K
X34-3010-11	CD04AS1HR47M(7)	YES	NO	NO	YES	YES	NO	30624MGPA27GP	YES	NO	22K	47K	YES	YES	47K	2.2K
X34-3010-21	CD04AS1HR47M(7)	YES	NO	NO	NO	YES	NO	30624MGPA27GP	YES	NO	22K	47K	YES	YES	47K	2.2K
X34-3010-22	CD04AS1HR47M(7)	YES	NO	NO	NO	YES	YES	30624MGPA26GP	YES	NO	22K	47K	YES	YES	47K	2.2K
X34-3012-71	CD04AS1HR47M(7)	YES	NO	NO	YES	YES	NO	30624MGPA27GP	YES	YES	22K	47K	NO	YES	47K	2.2K
X34-3012-72	CD04AS1HR47M(7)	NO	YES	NO	YES	NO	YES	30624MGPA27GP	YES	YES	22K	47K	NO	NO	100K	100
X34-3010-01	CD04AS1HR47M(7)	YES	NO	YES	NO	YES	NO	30624MGPA27GP	YES	NO	47K	100K	YES	YES	47K	2.2K
X34-3010-02	CD04AS1HR47M(7)	YES	NO	NO	NO	YES	NO	30624MGPA26GP	YES	NO	47K	100K	YES	YES	47K	2.2K
X34-3010-03	CD04AW1HR47M(7)	NO	YES	YES	NO	NO	YES	30624MGPA27GP	YES	NO	47K	100K	YES	NO	100K	100
X34-3222-70	CD04AS1HR47M(7)	YES	NO	NO	YES	NO	YES	30624MGPA27GP	YES	YES	22K	47K	NO	YES	47K	2.2K

UNIT No.	R258	R260	R261	R262	R263	R264	R265	R270,331	R274	R333	R472-475	W2	W200	W400-405
X34-3010-10	YES	NO	YES	NO	YES	NO	NO	NO	NO	NO	NO	NO	NO	NO
X34-3010-11	YES	YES	NO	NO	YES	YES	NO	NO	NO	NO	YES	NO	NO	YES
X34-3010-21	YES	YES	NO	YES	NO	NO	YES	NO	YES	NO	NO	NO	NO	YES
X34-3010-22	NO	NO	YES	NO	YES	NO	YES	NO	YES	NO	YES	NO	NO	YES
X34-3012-71	YES	YES	NO	NO	YES	NO	YES	NO	YES	NO	YES	YES	NO	YES
X34-3012-72	YES	NO	YES	YES	NO	YES	NO	YES	YES	NO	YES	YES	YES	YES
X34-3010-01	YES	NO	YES	NO	YES	YES	NO	NO	YES	YES	YES	NO	NO	NO
X34-3010-02	NO	YES	NO	YES	NO	YES	NO	YES	YES	YES	NO	NO	NO	YES
X34-3010-03	YES	YES	NO	YES	NO	NO	YES	NO	YES	YES	NO	NO	YES	NO
X34-3222-70	YES	YES	NO	NO	YES	NO	YES	NO	YES	NO	YES	YES	NO	YES

2SB1565

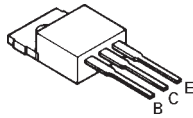

- DTA114EE
- DTA123JK
- DTA144EE
- DTC114YE
- DTC114YUA
- DTC124EE
- DTC143TE
- DTC143TUA
- 2SA1163-F
- 2SA1576A

2SC2713-F
2SC4617



2SB1188

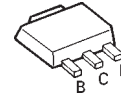

2SA1774
2SC4081

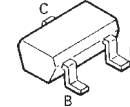

- DTA114EUA
- DTA124EUA
- DTC124EUA
- DTC144EUA

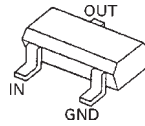

UMC2N

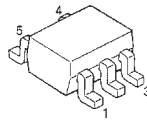

DAN202U



- DAP202U
- DA204K
- DA204U



DA227

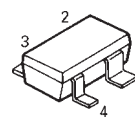

TC7SH08FU

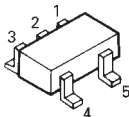

M5237ML

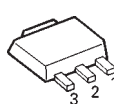

LB1930M-E

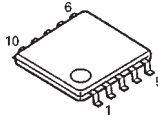

TC74HC4050AFT

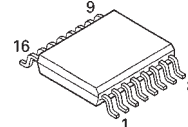

KDC-MP6025/MP625/MP858
KDC-W6527/W6527Y

(X16-2510-xx) (X16-2272-70)

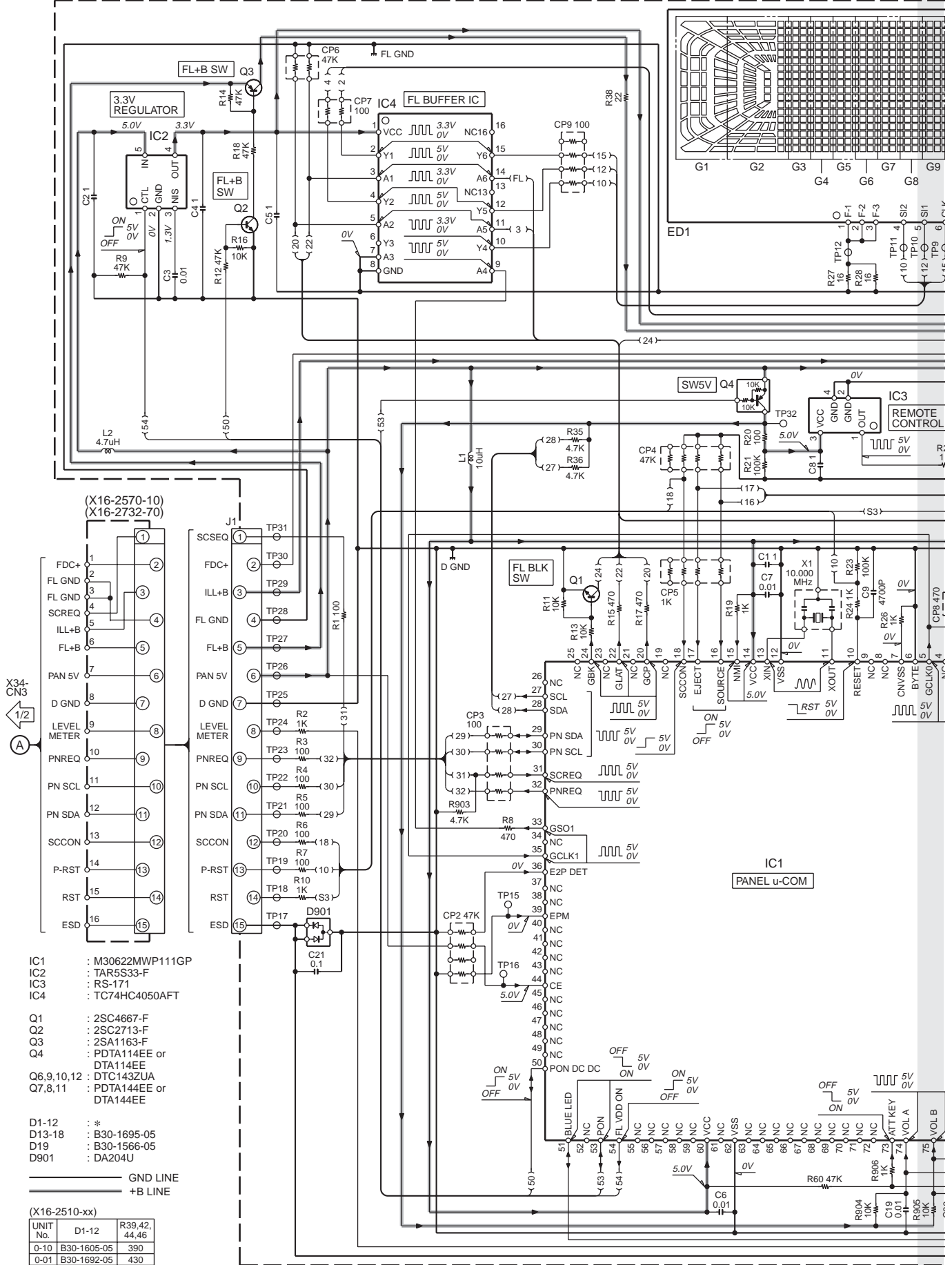

- IC1 : M30622MWP111GP
- IC2 : TAR5S33-F
- IC3 : RS-171
- IC4 : TC74HC4050AFT
- Q1 : 2SC4667-F
- Q2 : 2SC2713-F
- Q3 : 2SA1163-F
- Q4 : PDA1144EE or DTA1144EE
- Q6,9,10,12 : DTC143ZUA
- Q7,8,11 : PDA1144EE or DTA144EE
- D1-12 : *
- D13-18 : B30-1695-05
- D19 : B30-1566-05
- D901 : DA204U

— GND LINE
— +B LINE

(X16-2510-xx)		
UNIT No.	D1-12	R39,42,44,46
0-10	B30-1605-05	390
0-01	B30-1692-05	430

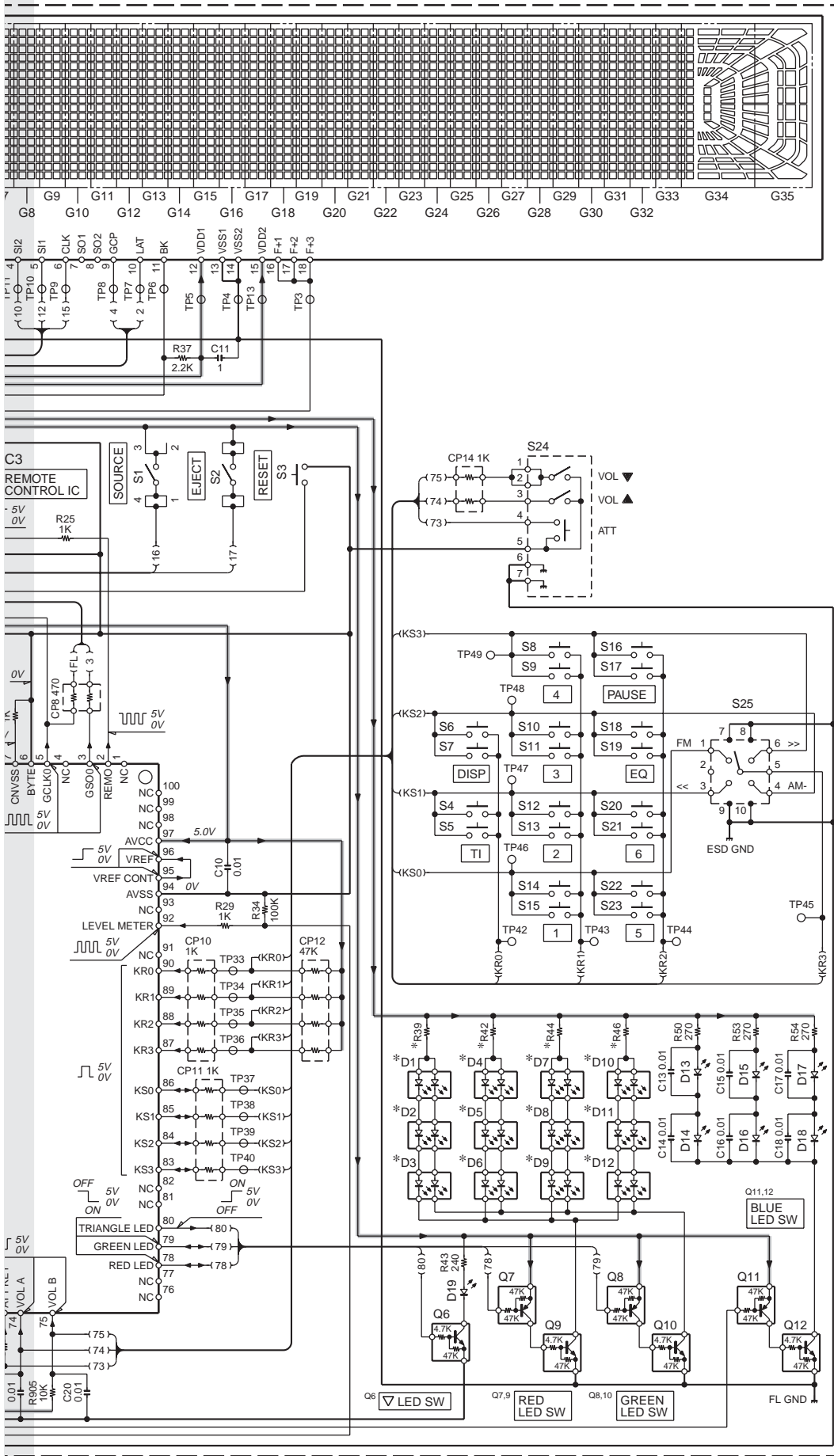

CAUTION : For continued safety, replace safety critical components only with manufacturer's recommended parts (refer to parts list).
 ⚠ Indicates safety critical components. To reduce the risk of electric shock, leakage-current or resistance measurements shall be carried out (exposed parts are acceptably insulated from the supply circuit) before the appliance is returned to the customer.

- DC voltages are as measured with a high impedance voltmeter. Values may vary slightly due to variations between individual instruments or/and units.

KDC-MP6025/MP625/MP858/W6527/W6527Y (2/2)

KDC-MP6025/MP625/MP858 KDC-W6527/W6527Y

CD PLAYER UNIT (X32-5500-00/01)

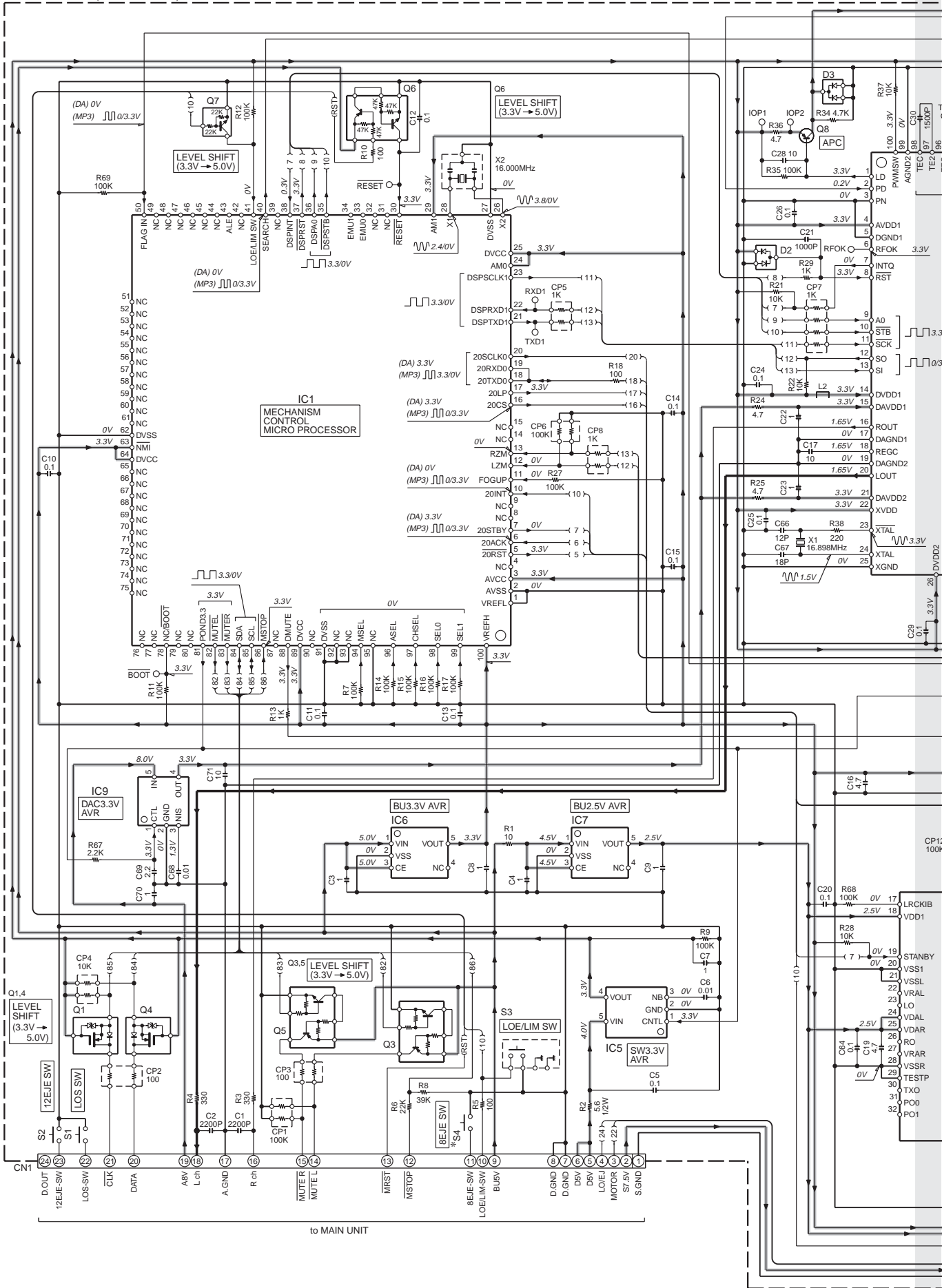

to MAIN UNIT

KDC-MP6025/MP625/MP858 KDC-W6527/W6527Y

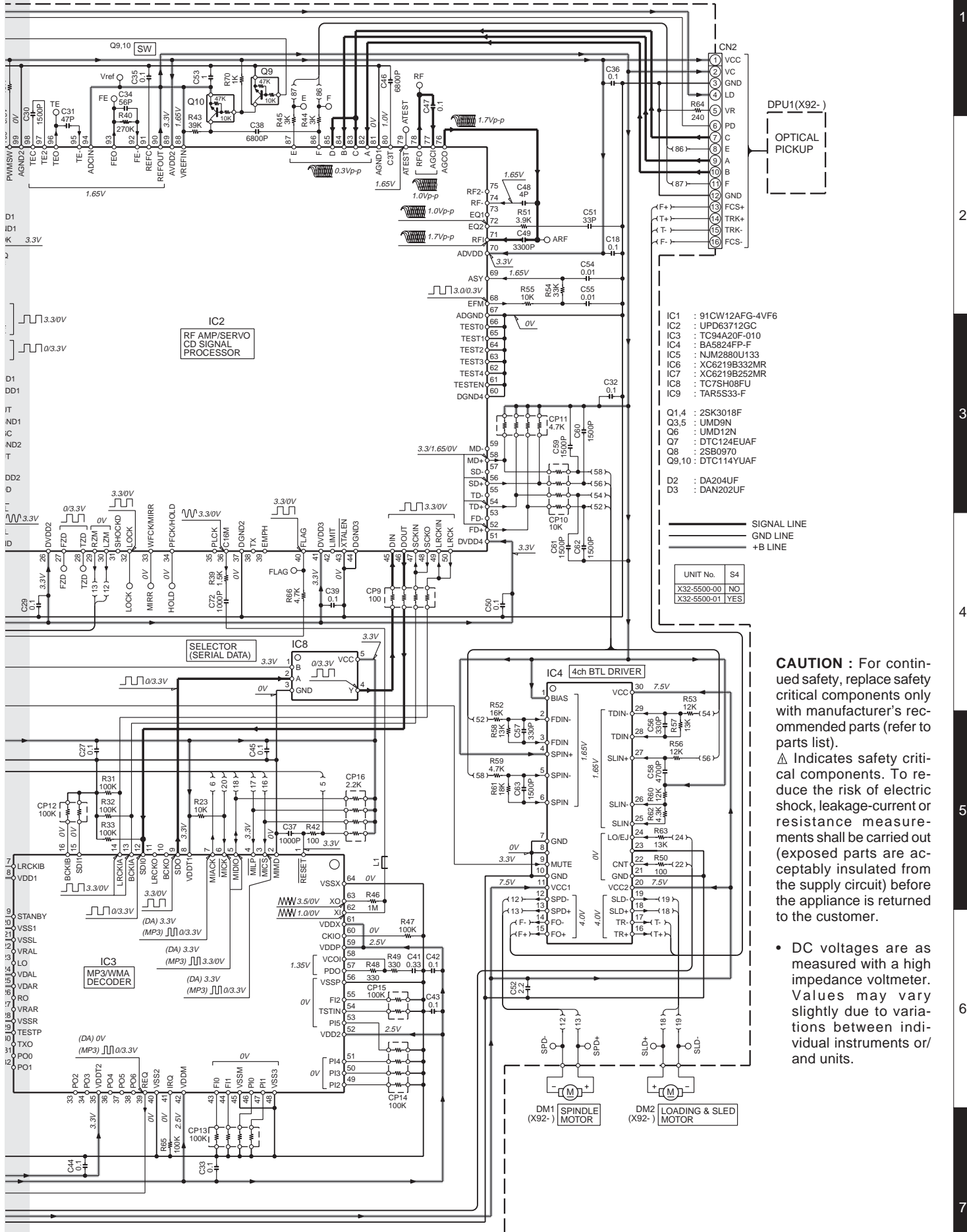

CAUTION : For continued safety, replace safety critical components only with manufacturer's recommended parts (refer to parts list).
 ⚠ Indicates safety critical components. To reduce the risk of electric shock, leakage-current or resistance measurements shall be carried out (exposed parts are acceptably insulated from the supply circuit) before the appliance is returned to the customer.

- DC voltages are as measured with a high impedance voltmeter. Values may vary slightly due to variations between individual instruments or/and units.

EXPLODED VIEW (MECHANISM)

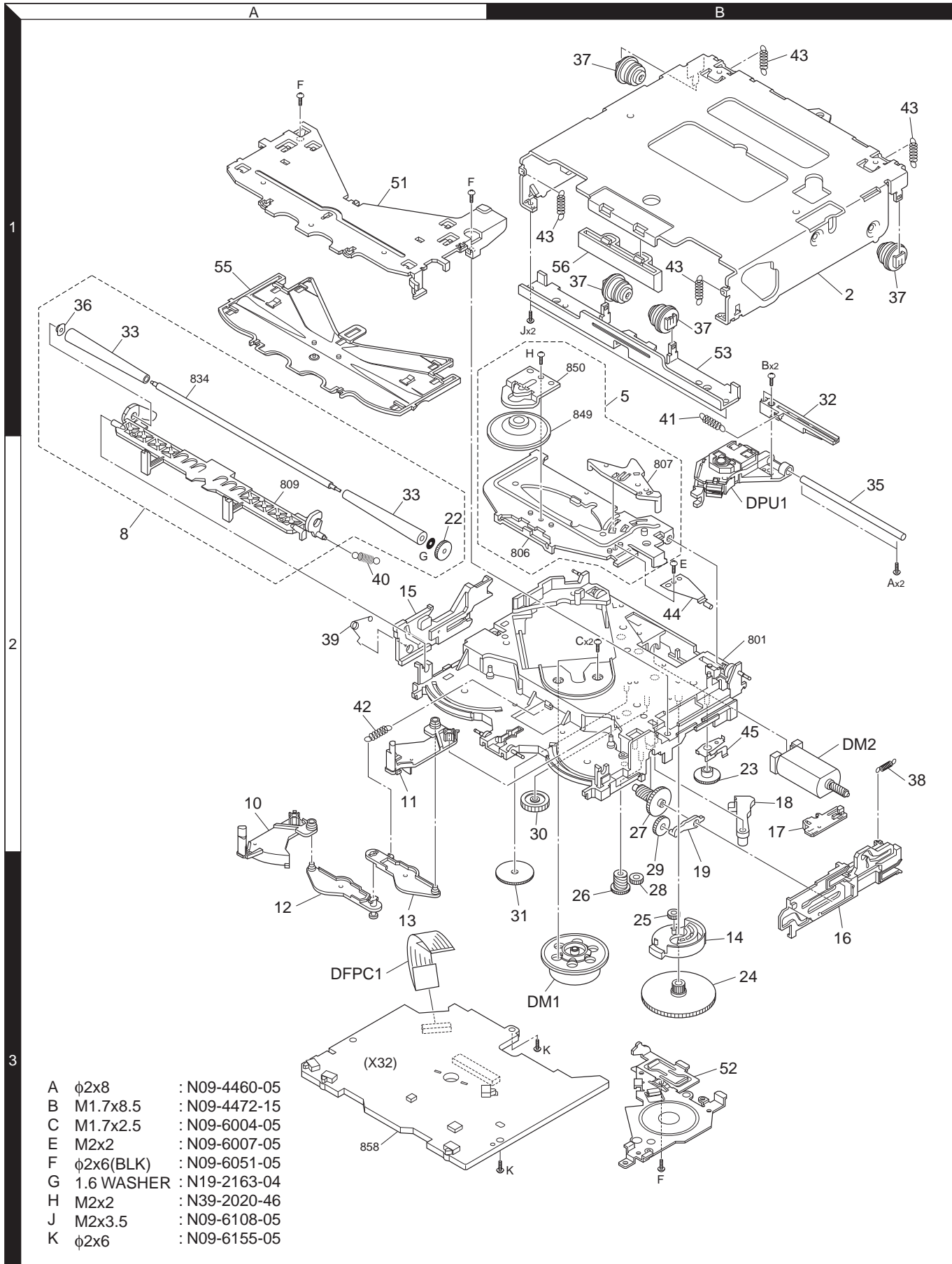

EXPLODED VIEW (UNIT)

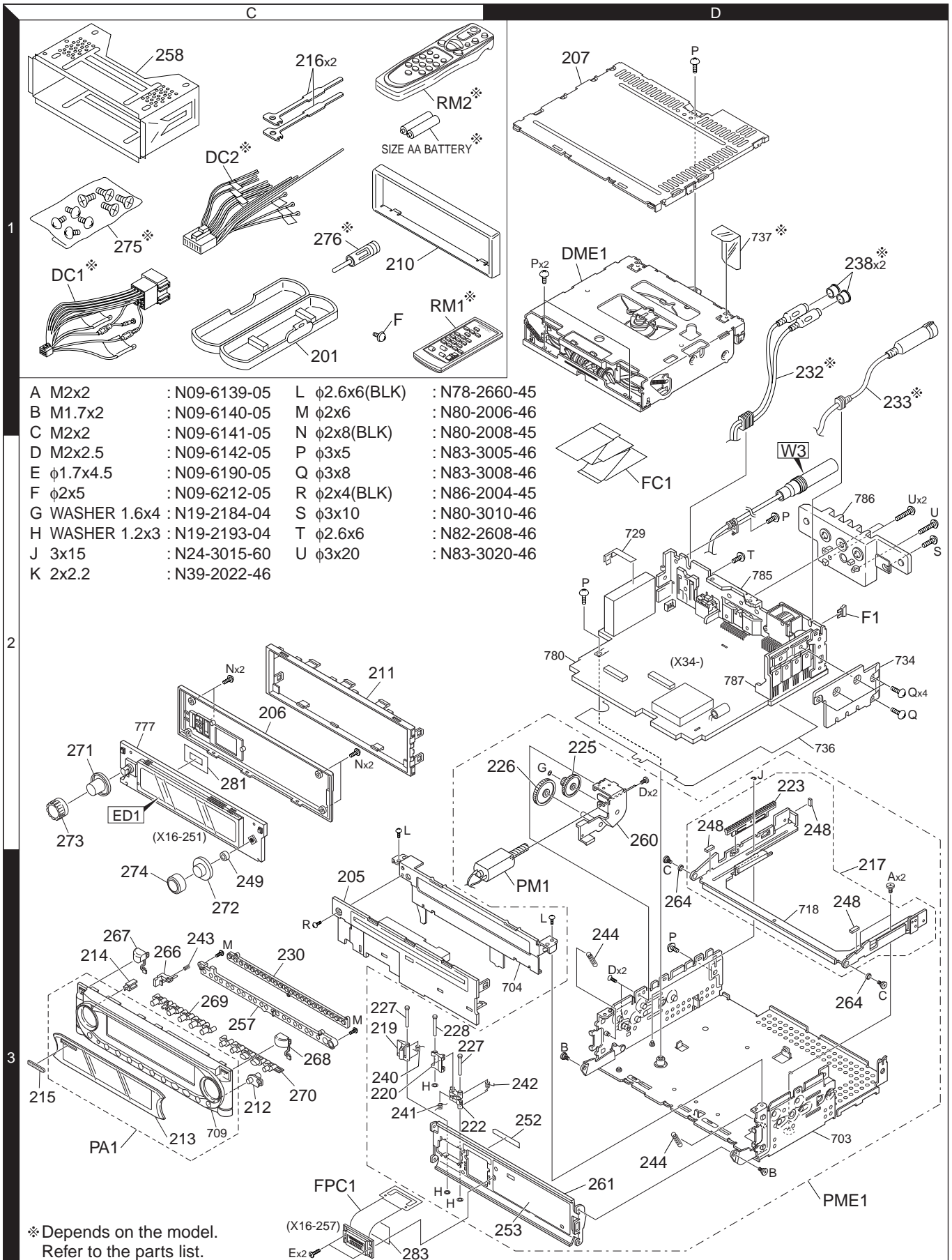

Parts with the exploded numbers larger than 700 are not supplied.

PARTS LIST

* New parts

Parts without **Parts No.** are not supplied.

Les articles non mentionnés dans le **Parts No.** ne sont pas fournis.

Teile ohne **Parts No.** werden nicht geliefert.

Ref. No.	A d d	N e w	Parts No.	Description	Desti- nation
KDC-MP6025/MP625/MP858/W6527/W6527Y					
201	1C	*	A02-2732-03	PLASTIC CABINET ASSY	
205	3C	*	A22-3023-12	SUB PANEL ASSY	
206	2C	*	A46-1798-01	REAR COVER	
207	1D	*	A52-0845-12	TOP PLATE	
PA1	3C		A64-3213-02	PANEL ASSY	K2
PA1	3C		A64-3214-02	PANEL ASSY	K3
PA1	3C	*	A64-3215-02	PANEL ASSY	M1
PA1	3C	*	A64-3217-02	PANEL ASSY	E1E
PME1	3D	*	A10-5112-12	CHASSIS ASSY	
RM1	1C	*	A70-2055-05	REMOTE CONTROLLER ASSY (RC-420)	E1E
RM2	1C	*	A70-2059-05	REMOTE CONTROLLER ASSY (RC-505)	K2K3M1
-			B46-0100-50	WARRANTY CARD	E
-			B46-0100-50	WARRANTY CARD	K2K3M1
-			B46-0606-04	ID CARD	K2K3
-			B46-0612-14	ID CARD	M1E1E
-		*	B64-2759-00	INSTRUCTION MANUAL (RUS.POL.)	E1
-		*	B64-2760-00	INSTRUCTION MANUAL (CZE.HUN.)	E1
-		*	B64-2761-00	INSTRUCTION MANUAL (CRO.SLO.)	E1
-		*	B64-2762-00	INSTRUCTION MANUAL (SWE.FIN.)	E1
-		*	B64-2763-00	INSTRUCTION MANUAL (ENGLISH)	E1
-		*	B64-2764-00	INSTRUCTION MANUAL (ENGLISH)	K2K3
-		*	B64-2765-00	INSTRUCTION MANUAL (FRE.SPA.)	K2K3
-		*	B64-2767-00	INSTRUCTION MANUAL (ENG.T-CHI.)	M1
-		*	B64-2773-00	INSTRUCTION MANUAL (ENGLISH)	E
-		*	B64-2774-00	INSTRUCTION MANUAL (FRE.GER.)	E
-		*	B64-2775-00	INSTRUCTION MANUAL (DUT.ITA.)	E
-		*	B64-2776-00	INSTRUCTION MANUAL (SPA.POR.)	E
210	1C		B07-3083-02	ESCUTCHEON	E1E
210	1C		B07-3098-02	ESCUTCHEON	K2M1
210	1C		B07-3100-02	ESCUTCHEON	K3
211	2C	*	B07-3095-02	ESCUTCHEON	
212	3C	*	B10-4509-04	FRONT GLASS	
213	3C		B10-4503-01	FRONT GLASS	K2
213	3C		B10-4504-01	FRONT GLASS	K3
213	3C	*	B10-4505-01	FRONT GLASS	M1
213	3C	*	B10-4507-01	FRONT GLASS	E1E
214	3C	*	B19-2245-04	LIGHTING BOARD	
215	3C		B43-1518-04	BADGE	
216	1C		D10-4589-04	LEVER	
217	3D	*	D10-4799-13	SLIDER ASSY	
219	3C	*	D10-4805-03	LEVER	
220	3C	*	D10-4806-03	LEVER	
222	3C	*	D10-4807-13	LEVER	
223	2D	*	D13-2318-13	RACK (GEAR)	
225	2D	*	D13-2320-04	GEAR	
226	2D	*	D13-2321-04	GEAR	
227	3C	*	D21-2442-04	SHAFT	
228	3C	*	D21-2443-04	SHAFT	
230	3C	*	E29-1970-03	CONDUCTIVE RUBBER	
232	1D	*	E30-6291-05	CORD WITH PINPLUG	E
232	1D	*	E30-6291-05	CORD WITH PINPLUG	K3M1E1
233	1D	*	E30-6292-05	CORD WITH DIN CONNECTOR	E1E

Ref. No.	A d d	N e w	Parts No.	Description	Desti- nation
DC1	1C	*	E30-6063-15	DC CORD	E1E
DC2	1C	*	E30-6294-05	DC CORD	M1
DC2	1C		E30-6295-05	DC CORD	K2K3
FC1	2D	*	E39-0617-05	FLAT CABLE (24P)	
238	1D		F29-0626-04	INSULATING COVER	E
238	1D		F29-0626-04	INSULATING COVER	K3M1E1
F1	2D		F52-0006-05	FUSE (MINI BLADE TYPE) 10A	
240	3C	*	G01-3210-04	TORSION COIL SPRING	
241	3C	*	G01-3211-04	TORSION COIL SPRING	
242	3C	*	G01-3212-04	TORSION COIL SPRING	
243	3C	*	G01-3213-04	COMPRESSION SPRING	
244	3D	*	G01-3215-04	EXTENSION SPRING	
248	3D	*	G11-3564-04	CUSHION	
249	3C	*	G11-3573-04	CUSHION	
252	3D	*	G16-1482-14	SHEET	
253	3D	*	G16-1483-04	SHEET	
-		*	H10-4890-02	POLYSTYRENE FOAMED FIXTURE	E1
-		*	H10-4890-02	POLYSTYRENE FOAMED FIXTURE	K2K3M1
-		*	H10-4891-02	POLYSTYRENE FOAMED FIXTURE	E
-			H25-0329-04	PROTECTION BAG (280X450X0.03)	
-			H25-0337-04	PROTECTION BAG (180X300X0.03)	
-			H54-3093-03	ITEM CARTON CASE	K2
-			H54-3094-03	ITEM CARTON CASE	K3
-		*	H54-3095-03	ITEM CARTON CASE	M1
-		*	H54-3097-03	ITEM CARTON CASE	E1
-		*	H54-3098-03	ITEM CARTON CASE	E
257	3C	*	J19-5273-02	HOLDER	
258	1C		J21-9716-03	MOUNTING HARDWARE ASSY	
260	3C	*	J22-0114-03	MOUNTING HARDWARE ASSY	
261	3D	*	J22-0117-02	MOUNTING HARDWARE	
264	3D	*	J31-1062-04	COLLAR	
266	3C	*	K24-4104-03	KNOB (RELEASE)	E1E
266	3C	*	K24-4172-03	KNOB (RELEASE)	K2M1
266	3C		K24-4173-03	KNOB (RELEASE)	K3
267	3C	*	K24-4128-03	KNOB (SRC)	E1E
267	3C	*	K24-4157-03	KNOB (SRC)	K2M1
267	3C		K24-4158-03	KNOB (SRC)	K3
268	3C	*	K24-4129-03	KNOB (EJECT)	E1E
268	3C	*	K24-4159-03	KNOB (EJECT)	K2M1
268	3C		K24-4160-03	KNOB (EJECT)	K3
269	3C	*	K25-1600-02	KNOB (1-4,AUTO)	
270	3C	*	K25-1640-02	KNOB (5-6,DISP)	
271	2C	*	K29-7084-03	KNOB BASE (VOL)	
272	3C	*	K29-7085-03	KNOB BASE (FM/AM)	
273	2C	*	K29-7086-03	KEY TOP (VOL)	
274	3C	*	K29-7087-03	KEY TOP (FM/AM)	
275	1C		N99-1723-05	SCREW SET	K2K3M1
A	3D	*	N09-6139-05	STEPPED SCREW (M2X2)	
B	3D	*	N09-6140-05	STEPPED SCREW (M1.7X2)	
C	3D	*	N09-6141-05	STEPPED SCREW (M2X2)	
D	3D	*	N09-6142-05	MACHINE SCREW (M2X2.5)	
E	3C	*	N09-6190-05	TAPPING SCREW (1.7X4.5)	
F	1C	*	N09-6212-05	TAPPING SCREW (2X5)	
G	2D	*	N19-2184-04	FLAT WASHER (1.6X4.0X0.25)	

E : KDC-W6527 E1 : KDC-W6527Y K2 : KDC-MP625
K3 : KDC-MP6025 M1 : KDC-MP858

△ Indicates safety critical components.

PARTS LIST

* New parts

Parts without **Parts No.** are not supplied.

Les articles non mentionnés dans le **Parts No.** ne sont pas fournis.

Teile ohne **Parts No.** werden nicht geliefert.

KDC-MP6025/MP625/MP858/W6527/W6527Y

Ref. No.	Add	New	Parts No.	Description	Destination
H	3C	*	N19-2193-04	FLAT WASHER (1.2X3.0X0.25)	
J	2D		N24-3015-60	E TYPE RETAINING RING	
L	3C	*	N78-2660-45	PAN HEAD TAPTITE SCREW	
M	3C		N80-2006-46	PAN HEAD TAPTITE SCREW	
N	2C		N80-2008-45	PAN HEAD TAPTITE SCREW	
P	1D		N83-3005-46	PAN HEAD TAPTITE SCREW	
Q	2D		N83-3008-46	PAN HEAD TAPTITE SCREW	
R	3C		N86-2004-45	BINDING HEAD TAPTITE SCREW	
276	1C		T90-0523-05	ANTENNA ADAPTOR	E1E
PM1	3D	*	T42-1086-14	MOTOR ASSY	
DME1	1D		X92-4850-00	CD MECHANISM ASSY	
SUB-CIRCUIT UNIT (X16-2510-10/X16-2722-70)					
D1-12		*	B30-1605-05	LED (2COLOR PG/RED)	
D13-18			B30-1695-05	LED (1608 BLUE K,L)	
D19			B30-1566-05	LED (1608,RED)	
C1,2			CK73GB0J105K	CHIP C 1.0UF K	
C3			CK73GB1H103K	CHIP C 0.010UF K	
C4,5			CK73GB0J105K	CHIP C 1.0UF K	
C6,7			CK73GB1H103K	CHIP C 0.010UF K	
C8			CK73GB0J105K	CHIP C 1.0UF K	
C9			CK73GB1H472K	CHIP C 4700PF K	
C10			CK73GB1H103K	CHIP C 0.010UF K	
C11			CK73GB0J105K	CHIP C 1.0UF K	
C13-20			CK73GB1H103K	CHIP C 0.010UF K	
C21			CK73GB1H104K	CHIP C 0.10UF K	
J1		*	E59-0839-05	RECTANGULAR PLUG	
281	2C	*	F20-2285-14	INSULATING SHEET	
L1			L40-1005-68	SMALL FIXED INDUCTOR	
L2			L40-4795-68	SMALL FIXED INDUCTOR (4.7UH)	
X1			L78-0858-05	RESONATOR	
CP2			RK74HB1J473J	CHIP-COM 47K J 1/16W	
CP3			RK74HB1J101J	CHIP-COM 100 J 1/16W	
CP4			RK74HB1J473J	CHIP-COM 47K J 1/16W	
CP5			RK74HB1J102J	CHIP-COM 1.0K J 1/16W	
CP6			RK74GA1J473J	CHIP-COM 47K J 1/16W	E1
CP6			RK74GA1J473J	CHIP-COM 47K J 1/16W	K2K3M1
CP6			RK74HB1J473J	CHIP-COM 47K J 1/16W	E
CP7			RK74GA1J101J	CHIP-COM 100 J 1/16W	
CP8		*	RK74GA1J471J	CHIP-COM 470 J 1/16W	
CP9			RK74HB1J101J	CHIP-COM 100 J 1/16W	
CP10,11			RK74HB1J102J	CHIP-COM 1.0K J 1/16W	
CP12			RK74HB1J473J	CHIP-COM 47K J 1/16W	
CP14			RK74GA1J102J	CHIP-COM 1.0K J 1/16W	
R1			RK73EB2E101J	CHIP R 100 J 1/4W	
R2			RK73EB2E102J	CHIP R 1.0K J 1/4W	
R3-7			RK73EB2E101J	CHIP R 100 J 1/4W	
R8			RK73GB2A471J	CHIP R 470 J 1/10W	
R9			RK73GB2A473J	CHIP R 47K J 1/10W	
R10			RK73EB2E102J	CHIP R 1.0K J 1/4W	
R11			RK73GB2A103J	CHIP R 10K J 1/10W	
R12			RK73GB2A473J	CHIP R 47K J 1/10W	

Ref. No.	Add	New	Parts No.	Description	Destination
R13			RK73GB2A103J	CHIP R 10K J 1/10W	
R14			RK73GB2A473J	CHIP R 47K J 1/10W	
R15			RK73GB2A471J	CHIP R 470 J 1/10W	
R16			RK73GB2A103J	CHIP R 10K J 1/10W	
R17			RK73GB2A471J	CHIP R 470 J 1/10W	
R18			RK73GB2A473J	CHIP R 47K J 1/10W	
R19			RK73GB2A102J	CHIP R 1.0K J 1/10W	
R20			RK73GB2A101J	CHIP R 100 J 1/10W	
R21			RK73GB2A104J	CHIP R 100K J 1/10W	
R23			RK73GB2A104J	CHIP R 100K J 1/10W	
R24-26			RK73GB2A102J	CHIP R 1.0K J 1/10W	
R27,28		*	RK73EB2E160J	CHIP R 16 J 1/4W	
R29			RK73GB2A102J	CHIP R 1.0K J 1/10W	
R34			RK73GB2A104J	CHIP R 100K J 1/10W	
R35,36			RK73GB2A472J	CHIP R 4.7K J 1/10W	
R37			RK73GB2A222J	CHIP R 2.2K J 1/10W	
R38			RK73GB2A220J	CHIP R 22 J 1/10W	
R39			RK73FB2B361J	CHIP R 360 J 1/8W	E
R39			RK73FB2B391J	CHIP R 390 J 1/8W	E1
R39			RK73FB2B391J	CHIP R 390 J 1/8W	K2K3M1
R42			RK73FB2B361J	CHIP R 360 J 1/8W	E
R42			RK73FB2B391J	CHIP R 390 J 1/8W	E1
R42			RK73FB2B391J	CHIP R 390 J 1/8W	K2K3M1
R43			RK73FB2B241J	CHIP R 240 J 1/8W	
R44			RK73FB2B361J	CHIP R 360 J 1/8W	E
R44			RK73FB2B391J	CHIP R 390 J 1/8W	E1
R44			RK73FB2B391J	CHIP R 390 J 1/8W	K2K3M1
R46			RK73FB2B361J	CHIP R 360 J 1/8W	E
R46			RK73FB2B391J	CHIP R 390 J 1/8W	E1
R46			RK73FB2B391J	CHIP R 390 J 1/8W	K2K3M1
R50			RK73FB2B271J	CHIP R 270 J 1/8W	
R53,54			RK73FB2B271J	CHIP R 270 J 1/8W	
R60			RK73GB2A473J	CHIP R 47K J 1/10W	
R903			RK73GB2A472J	CHIP R 4.7K J 1/10W	
R904,905			RK73GB2A103J	CHIP R 10K J 1/10W	
R906			RK73GB2A102J	CHIP R 1.0K J 1/10W	
S1,2			S70-0901-05	TACT SWITCH	
S25		*	S70-0920-05	TACT SWITCH	
S24		*	T99-0450-05	ROTARY ENCODER	
D901			DA204U	DIODE	
ED1		*	CN2100M	FLUORESCENT INDICATOR TUBE	
IC1		*	30622MWP111GP	MICROCONTROLLER IC	
IC2		*	TAR5S33-F	ANALOGUE IC	
IC3		*	RS-171	ANALOGUE IC	
IC4			TC74HC4050AFT	MOS-IC	
Q1		*	2SC4667-F	TRANSISTOR	
Q2		*	2SC2713-F	TRANSISTOR	
Q3		*	2SA1163-F	TRANSISTOR	
Q4			DTA114EE	DIGITAL TRANSISTOR	
Q4		*	PDTA114EE	TRANSISTOR	
Q6			DTC143ZUA	DIGITAL TRANSISTOR	
Q7,8			DTA144EE	DIGITAL TRANSISTOR	
Q7,8		*	PDTA144EE	TRANSISTOR	

E : KDC-W6527 E1 : KDC-W6527Y K2 : KDC-MP625
K3 : KDC-MP6025 M1 : KDC-MP858

△ Indicates safety critical components.

PARTS LIST

* New parts

Parts without **Parts No.** are not supplied.

Les articles non mentionnés dans le **Parts No.** ne sont pas fournis.

Teile ohne **Parts No.** werden nicht geliefert.

SUB-CIRCUIT UNIT (X16-2510-10/X16-2722-70)

Ref. No.	A d d	N e w	Parts No.	Description	Desti- nation
Q9,10 Q11 Q11 Q12		*	DTC143ZUA DTA144EE PDTA144EE DTC143ZUA	DIGITAL TRANSISTOR DIGITAL TRANSISTOR TRANSISTOR DIGITAL TRANSISTOR	
SUB-CIRCUIT UNIT (X16-2570-10/X16-2732-70)					
283	3C	*	F20-2284-14	INSULATING SHEET	
FPC1	3C	*	J86-0003-05	FPC (LEAD FREE)	
CD PLAYER UNIT (X32-5500-00)					
C1,2 C3,4 C5 C6 C7-9			CK73GB1H222K CK73GB0J105K CK73GB1C104K CK73GB1H103K CK73GB0J105K	CHIP C 2200PF K CHIP C 1.0UF K CHIP C 0.10UF K CHIP C 0.010UF K CHIP C 1.0UF K	
C10-15 C16 C17 C18 C19			CK73GB1C104K CK73FB0J475K CK73FB0J106M CK73GB1C104K CK73FB0J475K	CHIP C 0.10UF K CHIP C 4.7UF K CHIP C 10UF M CHIP C 0.10UF K CHIP C 4.7UF K	
C20 C21 C22,23 C24-27 C28			CK73GB1C104K CK73GB1H102K CK73GB0J105K CK73GB1C104K CK73FB0J106M	CHIP C 0.10UF K CHIP C 1000PF K CHIP C 1.0UF K CHIP C 0.10UF K CHIP C 10UF M	
C29 C30 C31 C32,33 C34			CK73GB1C104K CK73GB1H152K CC73GCH1H470J CK73GB1C104K CC73GCH1H560J	CHIP C 0.10UF K CHIP C 1500PF K CHIP C 47PF J CHIP C 0.10UF K CHIP C 56PF J	
C35,36 C37 C38 C39 C41			CK73GB1C104K CK73GB1H102K CK73GB1H682K CK73GB1C104K CK73GB1A334K	CHIP C 0.10UF K CHIP C 1000PF K CHIP C 6800PF K CHIP C 0.10UF K CHIP C 0.33UF K	
C42-45 C46 C47 C48 C49			CK73GB1C104K CK73GB1H682K CK73GB1C104K CC73GCH1H040C CK73GB1H332K	CHIP C 0.10UF K CHIP C 6800PF K CHIP C 0.10UF K CHIP C 4.0PF C CHIP C 3300PF K	
C50 C51 C52 C53 C54,55			CK73GB1C104K CC73GCH1H330J CK73FB1A225K CK73GB0J105K CK73GB1H103K	CHIP C 0.10UF K CHIP C 33PF J CHIP C 2.2UF K CHIP C 1.0UF K CHIP C 0.010UF K	
C56,57 C58 C59-63 C64 C66			CK73GB1H331K CK73GB1H472K CK73GB1H152K CK73GB1C104K CC73GCH1H120J	CHIP C 330PF K CHIP C 4700PF K CHIP C 1500PF K CHIP C 0.10UF K CHIP C 12PF J	
C67 C68 C69 C70 C71			CC73GCH1H180J CK73GB1H103K CK73FB1A225K CK73FB1A105K CK73FB0J106M	CHIP C 18PF J CHIP C 0.010UF K CHIP C 2.2UF K CHIP C 1.0UF K CHIP C 10UF M	

Ref. No.	A d d	N e w	Parts No.	Description	Desti- nation
C72			CK73GB1H102K	CHIP C 1000PF K	
CN1 CN2 CN2		*	E41-2083-05 E41-2068-05 E41-2085-05	FLAT CABLE CONNECTOR FLAT CABLE CONNECTOR FLAT CABLE CONNECTOR	
L1,2 X1 X2		*	L92-0386-05 L77-2808-05 L78-0896-05	CHIP FERRITE CRYSTAL RESONATOR (16.897849MHZ) RESONATOR (16.00MHZ)	
CP1 CP2,3 CP4 CP5 CP6			RK74GA1J104J RK74GA1J101J RK74GA1J103J RK74GA1J102J RK74GA1J104J	CHIP-COM 100K J 1/16W CHIP-COM 100 J 1/16W CHIP-COM 10K J 1/16W CHIP-COM 1.0K J 1/16W CHIP-COM 100K J 1/16W	
CP7 CP8 CP9 CP10 CP11			RK74GB1J102J RK74GA1J102J RK74GB1J101J RK74GB1J103J RK74GB1J472J	CHIP-COM 1.0K J 1/16W CHIP-COM 1.0K J 1/16W CHIP-COM 100 J 1/16W CHIP-COM 10K J 1/16W CHIP-COM 4.7K J 1/16W	
CP12 CP13,14 CP15 CP16 R1		*	RK74GA1J104J RK74GB1J104J RK74GA1J104J RK74GB1J222J RK73GB2A100J	CHIP-COM 100K J 1/16W CHIP-COM 100K J 1/16W CHIP-COM 100K J 1/16W CHIP-COM 2.2K J 1/16W CHIP R 10 J 1/10W	
R2 R3,4 R5 R6 R7			R92-3494-05 RK73FB2B331J RK73GB2A101J RN73GH1J223D RK73GB2A104J	CHIP R 5.6 F 1/2W CHIP R 330 J 1/8W CHIP R 100 J 1/10W CHIP R 22K D 1/16W CHIP R 100K J 1/10W	
R8 R9 R10 R11,12 R13			RN73GH1J393D RK73GB2A104J RK73GB2A101J RK73GB2A104J RK73GB2A102J	CHIP R 39K D 1/16W CHIP R 100K J 1/10W CHIP R 100 J 1/10W CHIP R 100K J 1/10W CHIP R 1.0K J 1/10W	
R14-17 R18 R21-23 R24,25 R27			RK73GB2A104J RK73GB2A101J RK73GB2A103J RK73GB2A4R7J RK73GB2A104J	CHIP R 100K J 1/10W CHIP R 100 J 1/10W CHIP R 10K J 1/10W CHIP R 4.7 J 1/10W CHIP R 100K J 1/10W	
R28 R29 R31-33 R34 R35			RK73GB2A103J RK73GB2A102J RK73GB2A104J RK73GB2A472J RK73GB2A104J	CHIP R 10K J 1/10W CHIP R 1.0K J 1/10W CHIP R 100K J 1/10W CHIP R 4.7K J 1/10W CHIP R 100K J 1/10W	
R36 R37 R38 R39 R40			RK73FB2B4R7J RK73GB2A103J RK73GB2A221J RK73GB2A152J RK73GB2A274J	CHIP R 4.7 J 1/8W CHIP R 10K J 1/10W CHIP R 220 J 1/10W CHIP R 1.5K J 1/10W CHIP R 270K J 1/10W	
R42 R43 R44,45 R46 R47			RK73GB2A101J RK73GB2A393J RK73GB2A302J RK73GB2A105J RK73GB2A104J	CHIP R 100 J 1/10W CHIP R 39K J 1/10W CHIP R 3.0K J 1/10W CHIP R 1.0M J 1/10W CHIP R 100K J 1/10W	
R48,49			RK73GB2A331J	CHIP R 330 J 1/10W	

PARTS LIST

* New parts

Parts without **Parts No.** are not supplied.

Les articles non mentionnés dans le **Parts No.** ne sont pas fournis.

Teile ohne **Parts No.** werden nicht geliefert.

CD PLAYER UNIT (X32-5500-00)

Ref. No.	Add	New	Parts No.	Description	Destination
R50			RK73GB2A101J	CHIP R 100 J 1/10W	
R51			RK73GB2A392J	CHIP R 3.9K J 1/10W	
R52			RK73GB2A163J	CHIP R 16K J 1/10W	
R53			RK73GB2A123J	CHIP R 12K J 1/10W	
R54			RK73GB2A333J	CHIP R 33K J 1/10W	
R55			RK73GB2A103J	CHIP R 10K J 1/10W	
R56			RK73GB2A123J	CHIP R 12K J 1/10W	
R57,58			RK73GB2A133J	CHIP R 13K J 1/10W	
R59			RK73GB2A472J	CHIP R 4.7K J 1/10W	
R60			RK73GB2A123J	CHIP R 12K J 1/10W	
R61			RK73GB2A183J	CHIP R 18K J 1/10W	
R62			RK73GB2A432J	CHIP R 4.3K J 1/10W	
R63			RK73GB2A133J	CHIP R 13K J 1/10W	
R64			RK73GB2A241J	CHIP R 240 J 1/10W	
R65			RK73GB2A104J	CHIP R 100K J 1/10W	
R66			RK73GB2A472J	CHIP R 4.7K J 1/10W	
R67			RK73GB2A222J	CHIP R 2.2K J 1/10W	
R68,69			RK73GB2A104J	CHIP R 100K J 1/10W	
R70			RK73GB2A102J	CHIP R 1.0K J 1/10W	
S1,2			S68-0863-05	PUSH SWITCH	
S3			S68-0862-05	PUSH SWITCH	
D2	*		DA204UF	DIODE	
D3			DAN202UF	DIODE	
IC1	*		91CW12AFG-4VF6	MICROCONTROLLER IC	
IC2			UPD63712GC	MOS-IC	
IC3	*		TC94A20F-010	MOS-IC	
IC4			BA5824FP-F	ANALOGUE IC	
IC5			NJM2880U133	ANALOGUE IC	
IC5			NJM2880U33	ANALOGUE IC	
IC6	*		S-1112B33MCG	ANALOGUE IC	
IC6	*		XC6219B332MR	ANALOGUE IC	
IC7	*		S-1112B25MCG	ANALOGUE IC	
IC7	*		XC6219B252MR	ANALOGUE IC	
IC8			TC7SH08FU	MOS-IC	
IC9	*		TAR5S33-F	ANALOGUE IC	
Q1	*		2SK3018F	FET	
Q3			UMD9N	TRANSISTOR	
Q4	*		2SK3018F	FET	
Q5			UMD9N	TRANSISTOR	
Q6			UMD12N	TRANSISTOR	
Q7	*		DTC124EUAF	DIGITAL TRANSISTOR	
Q8			2SB0970	TRANSISTOR	
Q9,10			DTC114YUAF	DIGITAL TRANSISTOR	
ELECTRIC UNIT (X34-301x-xx/X34-3222-70)					
D302			B30-1566-05	LED (1608,RED)	
C1	*		C90-5683-05	ELECTRO 3300UF 16WV	
C2			CK73GB1H103K	CHIP C 0.010UF K	
C3	*		C90-5692-05	ELECTRO 220UF 16WV	
C4			CK73GB1H103K	CHIP C 0.010UF K	
C5	*		CE32CL1C100M	CHIP EL 10UF 16WV	
C6			CD04AS0J101M	ELECTRO 100UF 6.3WV	
C7	*		CD04BE1J820M	ELECTRO 82UF 63WV	
C8			CK73FB1C105K	CHIP C 1.0UF K	

Ref. No.	Add	New	Parts No.	Description	Destination
C9			CD04AT1A221M	ELECTRO 220UF 10WV	
C10			CK73GB1A474K	CHIP C 0.47UF K	
C11			CD04AT1A101M	ELECTRO 100UF 10WV	
C12			CK73GB1A474K	CHIP C 0.47UF K	
C13			CD04AT1A101M	ELECTRO 100UF 10WV	
C14			CD04BF1E101M	ELECTRO 100UF 25WV	
C16	*		CD04BF1C101M	ELECTRO 100UF 16WV	
C17	*		C90-5680-05	ELECTRO 100UF 16WV	
C18			CK73FB1C334K	CHIP C 0.33UF K	
C19			CK73EB1C225K	CHIP C 2.2UF K	
C20			CK73GB1H103K	CHIP C 0.010UF K	
C21	*		C94-0151-05	ELECTRO 100UF 16WV	
C23	*		C90-5680-05	ELECTRO 100UF 16WV	
C112	*		CD04BA1H3R3M	ELECTRO 3.3UF 50WV	
C113			CK73GB0J105K	CHIP C 1.0UF K	
C114	*		CD04BA1H0R1M	ELECTRO 0.1UF 50WV	
C115			CK73GB1H103K	CHIP C 0.010UF K	
C116			CK73GB1E223K	CHIP C 0.022UF K	
C117			CK73FB1C105K	CHIP C 1.0UF K	
C118			CK73GB1H103K	CHIP C 0.010UF K	
C119			CK73GB1H102K	CHIP C 1000PF K	
C120,121			CK73GB1H103K	CHIP C 0.010UF K	
C201			CC73GCH1H220J	CHIP C 22PF J	
C202			CK73GB1H104K	CHIP C 0.10UF K	
C203			CC73GCH1H270J	CHIP C 27PF J	
C204-206			CK73GB1H103K	CHIP C 0.010UF K	
C207			CD04AS0J470M	ELECTRO 47UF 6.3WV	E1
C207			CD04AS0J470M	ELECTRO 47UF 6.3WV	K2K3M1
C208			CK73GB1H102K	CHIP C 1000PF K	
C209			CK73GB1H103K	CHIP C 0.010UF K	
C301,302			CK73GB1H103K	CHIP C 0.010UF K	
C303			CK73FB1C105K	CHIP C 1.0UF K	
C308			CC73GCH1H331J	CHIP C 330PF J	E1E
C309			CK73GB1H103K	CHIP C 0.010UF K	E1E
C310			CK73FB1A225K	CHIP C 2.2UF K	E1E
C311			CD04AS1C100M	ELECTRO 10UF 16WV	E1E
C312,313			CC73GCH1H120J	CHIP C 12PF J	E1E
C314-316			CK73GB1C104K	CHIP C 0.10UF K	
C317			CC73GCH1H220J	CHIP C 22PF J	
C318			CK73FB1C105K	CHIP C 1.0UF K	
C319			CD04AS1E4R7M	ELECTRO 4.7UF 25WV	
C320,321			CK73GB1H103K	CHIP C 0.010UF K	
C402			CK73GB1C104K	CHIP C 0.10UF K	
C403,404			CD04AS1C220M	ELECTRO 22UF 16WV	
C405			CK73GB1C104K	CHIP C 0.10UF K	
C407,408			CD04AS1C220M	ELECTRO 22UF 16WV	
C410,411			CK73GB1C104K	CHIP C 0.10UF K	
C449	*		CD04AS1C470M	ELECTRO 47UF 16WV	E
C450			CK73FB1C474K	CHIP C 0.47UF K	K3M1E1
C450			CK73FB1C474K	CHIP C 0.47UF K	
C451			CD04AS0J470M	ELECTRO 47UF 6.3WV	E
C451			CD04AS0J470M	ELECTRO 47UF 6.3WV	K3M1E1
C452			CK73FB1C474K	CHIP C 0.47UF K	E
C452			CK73FB1C474K	CHIP C 0.47UF K	K3M1E1
C453,454	*		CD04AS1H3R3M	ELECTRO 3.3UF 50WV	

E : KDC-W6527 E1 : KDC-W6527Y K2 : KDC-MP625
K3 : KDC-MP6025 M1 : KDC-MP858

△ Indicates safety critical components.

PARTS LIST

* New parts

Parts without **Parts No.** are not supplied.

Les articles non mentionnés dans le **Parts No.** ne sont pas fournis.

Teile ohne **Parts No.** werden nicht geliefert.

ELECTRIC UNIT (X34-301x-xx/X34-3222-70)

Ref. No.	A d d	N e w	Parts No.	Description	Desti- nation
C455			CK73GB1A474K	CHIP C 0.47UF K	
C456			CC73GCH1H221J	CHIP C 220PF J	
C457,458			CK73GB1C104K	CHIP C 0.10UF K	
C461			CK73GB1H103K	CHIP C 0.010UF K	
C462-465			CK73FB1C105K	CHIP C 1.0UF K	E
C462-465			CK73FB1C105K	CHIP C 1.0UF K	K3M1E1
C462,463			CK73FB1C105K	CHIP C 1.0UF K	K2
C466-469			CK73FB1A225K	CHIP C 2.2UF K	E
C466-469			CK73FB1A225K	CHIP C 2.2UF K	K3M1E1
C466,467			CK73FB1A225K	CHIP C 2.2UF K	K2
C478			CD04AS1H2R2M	ELECTRO 2.2UF 50WV	
C479,480			CD04AS1HR47M	ELECTRO 0.47UF 50WV	
C483			CK73FB1C105K	CHIP C 1.0UF K	E
C483-485			CK73FB1C105K	CHIP C 1.0UF K	E1
C483-485			CK73FB1C105K	CHIP C 1.0UF K	K2K3M1
C501			CK73GB1H103K	CHIP C 0.010UF K	
C507			CK73GB1H103K	CHIP C 0.010UF K	E
C507			CK73GB1H103K	CHIP C 0.010UF K	K3M1E1
C509			CK73GB1H103K	CHIP C 0.010UF K	
C510			CK73FB1C474K	CHIP C 0.47UF K	
C511			CD04AS0J470M	ELECTRO 47UF 6.3WV	E1
C511			CD04AS0J470M	ELECTRO 47UF 6.3WV	K2K3M1
C512			CK73FB1C474K	CHIP C 0.47UF K	
C513			CK73GB1H103K	CHIP C 0.010UF K	
C514			CK73FB1C105K	CHIP C 1.0UF K	
C515		*	CD04AS1C330M	ELECTRO 33UF 16WV	
C516-519			C90-5620-05	ELECTRO 0.47UF 50WV	
C520			CK73FB1C105K	CHIP C 1.0UF K	
C521,522		*	CD04BA1H010M	ELECTRO 1UF 50WV	
CN1		*	E41-2083-05	FLAT CABLE CONNECTOR	
CN3		*	E41-2101-05	FLAT CABLE CONNECTOR	
CN5		*	E41-2123-05	PIN ASSY	
CN6		*	E41-0956-05	PIN ASSY	E
CN6		*	E41-0956-05	PIN ASSY	K3M1E1
CN7		*	E41-0944-05	PIN ASSY	E
CN7		*	E41-0944-05	PIN ASSY	K2K3E1
J1		*	E58-0991-05	RECTANGULAR RECEPTACLE	
J2		*	E56-0855-05	CYLINDRICAL RECEPTACLE	
J3		*	E63-0896-05	PIN JACK	
W3			E30-6218-05	CORD WITH PLUG	
L1		*	L33-1988-05	CHOKE COIL ASSY	
L2		*	L33-1978-05	CHOKE COIL	
L3		*	L33-1902-15	SMALL FIXED INDUCTOR	
L4			L33-1029-05	SMALL FIXED INDUCTOR	
L201			L40-4795-68	SMALL FIXED INDUCTOR (4.7UH)	
L202			L92-0075-05	CHIP FERRITE	
L301		*	L33-1977-05	CHOKE COIL	
L302-305			L40-1005-68	SMALL FIXED INDUCTOR	
L306			L40-4795-68	SMALL FIXED INDUCTOR (4.7UH)	E1E
L401			L40-4795-68	SMALL FIXED INDUCTOR (4.7UH)	
X1		*	L77-2880-05	CRYSTAL RESONATOR	
X2			L78-0862-05	RESONATOR (16.00MHZ)	
X3			L77-2002-05	CRYSTAL RESONATOR	E1E

Ref. No.	A d d	N e w	Parts No.	Description	Desti- nation
P	2D		N83-3005-46	PAN HEAD TAPTITE SCREW	
S	2D		N80-3010-46	PAN HEAD TAPTITE SCREW	
T	2D		N82-2608-46	BINDING HEAD TAPTITE SCREW	
U	2D		N83-3020-46	PAN HEAD TAPTITE SCREW	
CP202			RK74GA1J101J	CHIP-COM 100 J 1/16W	
CP203			RK74GB1J102J	CHIP-COM 1.0K J 1/16W	
CP204			RK74GA1J103J	CHIP-COM 10K J 1/16W	
CP205		*	RK74GA1J222J	CHIP-COM 2.2K J 1/16W	
CP206			RK74GB1J102J	CHIP-COM 1.0K J 1/16W	
CP207-209			RK74GB1J101J	CHIP-COM 100 J 1/16W	E
CP207-209			RK74GB1J101J	CHIP-COM 100 J 1/16W	K2K3E1
CP208,209			RK74GB1J101J	CHIP-COM 100 J 1/16W	M1
R1			RK73FB2B223J	CHIP R 22K J 1/8W	
R2			RK73GB2A101J	CHIP R 100 J 1/10W	
R3			RK73GB2A223J	CHIP R 22K J 1/10W	
R4			RK73GB2A222J	CHIP R 2.2K J 1/10W	
R5			RK73FB2B221J	CHIP R 220 J 1/8W	
R6			RK73GB2A153J	CHIP R 15K J 1/10W	
R7		*	RK73GH2A432D	CHIP R 4.3K D 1/10W	
R8		*	RK73GH2A243D	CHIP R 24K D 1/10W	
R9,10			RK73FB2B152J	CHIP R 1.5K J 1/8W	
R11			RK73GB2A102J	CHIP R 1.0K J 1/10W	
R12			RK73FB2B751J	CHIP R 750 J 1/8W	
R14			RK73GB2A473J	CHIP R 47K J 1/10W	
R15,16			RK73GB2A104J	CHIP R 100K J 1/10W	
R101			RK73EB2E102J	CHIP R 1.0K J 1/4W	E
R101			RK73EB2E102J	CHIP R 1.0K J 1/4W	K3M1E1
R102,103			RK73EB2E103J	CHIP R 10K J 1/4W	
R115			RK73FB2B472J	CHIP R 4.7K J 1/8W	
R116,117		*	R92-5024-05	CHIP R 1.0K J 3/4W	K2K3M1
R118			RK73GB2A223J	CHIP R 22K J 1/10W	K2K3M1
R119			RK73FB2B472J	CHIP R 4.7K J 1/8W	
R120		*	R92-5024-05	CHIP R 1.0K J 3/4W	
R121			RK73GB2A223J	CHIP R 22K J 1/10W	
R122		*	R92-5024-05	CHIP R 1.0K J 3/4W	
R123			RK73FB2B561J	CHIP R 560 J 1/8W	M1E1E
R124			RK73GB2A223J	CHIP R 22K J 1/10W	
R125			RK73GB2A473J	CHIP R 47K J 1/10W	
R126			RK73GB2A104J	CHIP R 100K J 1/10W	
R127			RK73GB2A103J	CHIP R 10K J 1/10W	
R128			RK73FB2B203J	CHIP R 20K J 1/8W	
R129			RK73GB2A104J	CHIP R 100K J 1/10W	
R130			RD14DB2H332J	SMALL-RD 3.3K J 1/2W	
R131			RK73EB2E473J	CHIP R 47K J 1/4W	
R132			RK73EB2E101J	CHIP R 100 J 1/4W	
R133,134			RK73GB2A103J	CHIP R 10K J 1/10W	
R135			RK73GB2A183J	CHIP R 18K J 1/10W	
R136			RK73GB2A104J	CHIP R 100K J 1/10W	
R137			RK73GB2A223J	CHIP R 22K J 1/10W	
R138		*	RK73FB2B683J	CHIP R 68K J 1/8W	
R139			RK73GB2A393J	CHIP R 39K J 1/10W	
R140			RK73GB2A333J	CHIP R 33K J 1/10W	
R141			RK73GB2A474J	CHIP R 470K J 1/10W	
R201			RK73GB2A104J	CHIP R 100K J 1/10W	

E : KDC-W6527
K3 : KDC-MP6025

E1 : KDC-W6527Y
M1 : KDC-MP858

K2 : KDC-MP625

△ Indicates safety critical components.

PARTS LIST

* New parts

Parts without **Parts No.** are not supplied.

Les articles non mentionnés dans le **Parts No.** ne sont pas fournis.

Teile ohne **Parts No.** werden nicht geliefert.

ELECTRIC UNIT (X34-301x-xx/X34-3222-70)

Ref. No.	Add	New	Parts No.	Description	Destination	Ref. No.	Add	New	Parts No.	Description	Destination
R202			RK73GB2A222J	CHIP R 2.2K J 1/10W		R312			RK73GB2A124J	CHIP R 120K J 1/10W	E1
R203			RK73GB2A472J	CHIP R 4.7K J 1/10W		R312			RK73GB2A124J	CHIP R 120K J 1/10W	K2K3M1
R206			RK73GB2A104J	CHIP R 100K J 1/10W		R312			RK73GB2A224J	CHIP R 220K J 1/10W	E
R207			RK73GB2A102J	CHIP R 1.0K J 1/10W		R313			RK73GB2A104J	CHIP R 100K J 1/10W	
R208			RK73GB2A103J	CHIP R 10K J 1/10W		R314			RK73GB2A472J	CHIP R 4.7K J 1/10W	
R210			RK73GB2A473J	CHIP R 47K J 1/10W	E1E	R315,316			RK73GB2A223J	CHIP R 22K J 1/10W	
R210,211			RK73GB2A473J	CHIP R 47K J 1/10W	K2K3M1	R317			RK73GB2A472J	CHIP R 4.7K J 1/10W	
R212			RK73GB2A104J	CHIP R 100K J 1/10W		R318-320			RK73EB2E102J	CHIP R 1.0K J 1/4W	
R213-215			RK73GB2A102J	CHIP R 1.0K J 1/10W		R321-323			RK73EB2E101J	CHIP R 100 J 1/4W	
R216			RK73GB2A223J	CHIP R 22K J 1/10W		R324			RK73EB2E472J	CHIP R 4.7K J 1/4W	
R217,218			RK73GB2A473J	CHIP R 47K J 1/10W	K2K3M1	R325			RK73EB2E101J	CHIP R 100 J 1/4W	
R219,220			RK73GB2A472J	CHIP R 4.7K J 1/10W		R326,327			RK73GB2A104J	CHIP R 100K J 1/10W	
R221,222			RK73GB2A471J	CHIP R 470 J 1/10W		R328			RK73GB2A472J	CHIP R 4.7K J 1/10W	
R223			RK73GB2A101J	CHIP R 100 J 1/10W		R329			RK73GB2A471J	CHIP R 470 J 1/10W	
R224			RK73GB2A472J	CHIP R 4.7K J 1/10W		R330			RK73GB2A104J	CHIP R 100K J 1/10W	
R225			RK73GB2A101J	CHIP R 100 J 1/10W		R332			RK73GB2A471J	CHIP R 470 J 1/10W	
R226			RK73GB2A473J	CHIP R 47K J 1/10W		R403			RK73GB2A333J	CHIP R 33K J 1/10W	
R227			RK73GB2A104J	CHIP R 100K J 1/10W		R407			RK73FB2B181J	CHIP R 180 J 1/8W	
R229			RK73GB2A471J	CHIP R 470 J 1/10W		R408,409			RK73GB2A223J	CHIP R 22K J 1/10W	
R230			RK73GB2A472J	CHIP R 4.7K J 1/10W		R410			RK73FB2B181J	CHIP R 180 J 1/8W	
R231			RK73GB2A471J	CHIP R 470 J 1/10W		R411,412			RK73FB2B361J	CHIP R 360 J 1/8W	
R232			RK73GB2A472J	CHIP R 4.7K J 1/10W		R415			RK73GB2A333J	CHIP R 33K J 1/10W	
R236			RK73GB2A473J	CHIP R 47K J 1/10W		R419			RK73FB2B181J	CHIP R 180 J 1/8W	
R239			RK73GB2A102J	CHIP R 1.0K J 1/10W		R420,421			RK73GB2A223J	CHIP R 22K J 1/10W	
R240			RK73GB2A473J	CHIP R 47K J 1/10W		R422			RK73FB2B181J	CHIP R 180 J 1/8W	
R241			RK73GB2A102J	CHIP R 1.0K J 1/10W		R423,424			RK73FB2B361J	CHIP R 360 J 1/8W	
R245			RK73GB2A473J	CHIP R 47K J 1/10W		R461			RK73GB2A103J	CHIP R 10K J 1/10W	
R247			RK73GB2A473J	CHIP R 47K J 1/10W		R462			RK73GB2A272J	CHIP R 2.7K J 1/10W	
R250,251			RK73GB2A222J	CHIP R 2.2K J 1/10W		R463,464			RK73GB2A472J	CHIP R 4.7K J 1/10W	
R252			RK73GB2A101J	CHIP R 100 J 1/10W		R468			RK73FB2B361J	CHIP R 360 J 1/8W	
R253			RK73GB2A222J	CHIP R 2.2K J 1/10W		R469,470			RK73GB2A473J	CHIP R 47K J 1/10W	
R254			RK73GB2A473J	CHIP R 47K J 1/10W		R471			RK73FB2B361J	CHIP R 360 J 1/8W	K2
R257-259			RK73GB2A473J	CHIP R 47K J 1/10W	K2	R471,472			RK73FB2B361J	CHIP R 360 J 1/8W	E
R257-260			RK73GB2A473J	CHIP R 47K J 1/10W	E	R471,472			RK73FB2B361J	CHIP R 360 J 1/8W	K3M1E1
R257-260			RK73GB2A473J	CHIP R 47K J 1/10W	K3M1E1	R473,474			RK73GB2A473J	CHIP R 47K J 1/10W	E
R261			RK73GB2A473J	CHIP R 47K J 1/10W	K2	R473,474			RK73GB2A473J	CHIP R 47K J 1/10W	K3M1E1
R262			RK73GB2A473J	CHIP R 47K J 1/10W	M1	R475			RK73FB2B361J	CHIP R 360 J 1/8W	E
R263			RK73GB2A473J	CHIP R 47K J 1/10W	K2E1E	R475			RK73FB2B361J	CHIP R 360 J 1/8W	K3M1E1
R263,264			RK73GB2A473J	CHIP R 47K J 1/10W	K3	R480,481			RK73GB2A104J	CHIP R 100K J 1/10W	
R265			RK73GB2A473J	CHIP R 47K J 1/10W	E	R501			RK73EB2E100J	CHIP R 10 J 1/4W	E
R265			RK73GB2A473J	CHIP R 47K J 1/10W	K2M1E1	R501			RK73EB2E100J	CHIP R 10 J 1/4W	K3M1E1
R272-274			RK73GB2A222J	CHIP R 2.2K J 1/10W	M1E1E	R502			RK73EB2E4R7J	CHIP R 4.7 J 1/4W	E
R272,273			RK73GB2A222J	CHIP R 2.2K J 1/10W	K2K3	R502			RK73EB2E4R7J	CHIP R 4.7 J 1/4W	K3M1E1
R276-278			RK73GB2A473J	CHIP R 47K J 1/10W		R503			RK73EB2E100J	CHIP R 10 J 1/4W	E
R279			RK73GB2A104J	CHIP R 100K J 1/10W		R503			RK73EB2E100J	CHIP R 10 J 1/4W	K3M1E1
R280,281			RK73GB2A222J	CHIP R 2.2K J 1/10W		R504			RK73GB2A102J	CHIP R 1.0K J 1/10W	E
R282,283			RK73GB2A104J	CHIP R 100K J 1/10W		R504			RK73GB2A102J	CHIP R 1.0K J 1/10W	K3M1E1
R284,285			RK73GB2A101J	CHIP R 100 J 1/10W		R505			RK73EB2E102J	CHIP R 1.0K J 1/4W	E
R301			RK73FB2B102J	CHIP R 1.0K J 1/8W		R505			RK73EB2E102J	CHIP R 1.0K J 1/4W	K2K3E1
R302			RK73GB2A223J	CHIP R 22K J 1/10W		R506-508			RK73EB2E471J	CHIP R 470 J 1/4W	E
R303			RK73GB2A472J	CHIP R 4.7K J 1/10W	E1E	R506-508			RK73EB2E471J	CHIP R 470 J 1/4W	K2K3E1
R304-306			RK73GB2A222J	CHIP R 2.2K J 1/10W	E1E	R509			RK73EB2E472J	CHIP R 4.7K J 1/4W	
R307,308			RK73GB2A102J	CHIP R 1.0K J 1/10W		R510			RK73EB2E101J	CHIP R 100 J 1/4W	
R309			RK73GB2A241J	CHIP R 240 J 1/10W		R511			RK73EB2E472J	CHIP R 4.7K J 1/4W	
R310,311			RK73GB2A103J	CHIP R 10K J 1/10W		R512-516			RK73EB2E101J	CHIP R 100 J 1/4W	

E : KDC-W6527 E1 : KDC-W6527Y K2 : KDC-MP625
K3 : KDC-MP6025 M1 : KDC-MP858

△ Indicates safety critical components.

PARTS LIST

* New parts

Parts without **Parts No.** are not supplied.

Les articles non mentionnés dans le **Parts No.** ne sont pas fournis.

Teile ohne **Parts No.** werden nicht geliefert.

ELECTRIC UNIT (X34-301x-xx/X34-3222-70)

Ref. No.	A d d	N e w	Parts No.	Description	Desti- nation
R517			RK73EB2E100J	CHIP R 10 J 1/4W	
R518			RK73EB2E4R7J	CHIP R 4.7 J 1/4W	
R519			RK73EB2E100J	CHIP R 10 J 1/4W	
R520			RK73GB2A102J	CHIP R 1.0K J 1/10W	
R521			RK73GB2A473J	CHIP R 47K J 1/10W	
R522			RK73GB2A752J	CHIP R 7.5K J 1/10W	
R523			RK73GB2A100J	CHIP R 10 J 1/10W	
R524			RK73GB2A432J	CHIP R 4.3K J 1/10W	
R525			RK73GB2A223J	CHIP R 22K J 1/10W	
R526,527			RK73GB2A221J	CHIP R 220 J 1/10W	
R528			RK73GB2A683J	CHIP R 68K J 1/10W	
R529			RK73GB2A103J	CHIP R 10K J 1/10W	
W2			R92-1252-05	CHIP R 0 OHM J 1/16W	E1E
W400			R92-1252-05	CHIP R 0 OHM J 1/16W	
W401,402			R92-2052-05	CHIP R 0 OHM J 1/10W	
W403			R92-1252-05	CHIP R 0 OHM J 1/16W	
W404,405			R92-2052-05	CHIP R 0 OHM J 1/10W	
S1,2		*	S68-0886-05	PUSH SWITCH	
D1		*	S2V60*A	DIODE	
D2			RB160L-40	DIODE	
D3			UDZS5.6B	ZENER DIODE	
D4			UDZS8.2B	ZENER DIODE	
D5		*	SFPB-54VNF	DIODE	
D6		*	HZU11(B1)-E	ZENER DIODE	
D7		*	HZU9.1(B1)-E	ZENER DIODE	
D103-107			1SR154-400	DIODE	M1E1E
D108			UDZS5.6B	ZENER DIODE	
D109			UDZS4.7B	ZENER DIODE	
D110,111			UDZS6.8B	ZENER DIODE	
D112			UDZS6.2B	ZENER DIODE	
D113,114			DAP202U	DIODE	
D115			DAN202U	DIODE	
D201			DAP202U	DIODE	
D300			DA204K	DIODE	
D301		*	IMSA-6801-E	SURGE ABSORBER	
D303		*	STZ6.2N	ZENER DIODE	
D304			DA204K	DIODE	
D305		*	STZ6.2N	ZENER DIODE	
D306			DA204K	DIODE	
D307		*	STZ6.2N	ZENER DIODE	
D308,309			DA204K	DIODE	
D310			DA204U	DIODE	
D314			STZ6.8N	ZENER DIODE	
D315			DA204U	DIODE	
D401			DA227	DIODE	E
D403,404			STZ6.8N	ZENER DIODE	E
D403,404			STZ6.8N	ZENER DIODE	K3M1E1
D500		*	STZ6.2N	ZENER DIODE	M1
D500-504		*	STZ6.2N	ZENER DIODE	E
D500-504		*	STZ6.2N	ZENER DIODE	K2K3E1
D503,504		*	STZ6.2N	ZENER DIODE	M1
D505,506			STZ6.8N	ZENER DIODE	
D507-510			1SR154-400	DIODE	

Ref. No.	A d d	N e w	Parts No.	Description	Desti- nation
D511,512			DAP222	DIODE	
D513-516			1SR154-400	DIODE	
D518			DAP222	DIODE	
D519			DA204U	DIODE	
IC1		*	30624MGPA27GP	MICROCONTROLLER IC	
IC2		*	E-TDA7414	ANALOGUE IC	
IC3			M5237ML	ANALOGUE IC	
IC4		*	E-TDA7560A	ANALOGUE IC	
IC7		*	SI-8050JDNF	ANALOGUE IC	
IC10		*	TC7W02FU-F	MOS-IC	
IC11		*	PST3436UL-E	MOS-IC	E1E
IC12		*	E-TDA7479AD	ANALOGUE IC	
IC13		*	LB1930M-E	ANALOGUE IC	
IC14		*	TA75S558F-F	ANALOGUE IC	
IC20		*	SI-3050KD	ANALOGUE IC	
Q1			2SB1565	TRANSISTOR	
Q2			2SC4081	TRANSISTOR	
Q3			2SA1576A	TRANSISTOR	
Q4		*	DTC124EE	DIGITAL TRANSISTOR	
Q4		*	PDTC124EE	TRANSISTOR	
Q5,6			UMC2N	TRANSISTOR	
Q7			2SB1188(R)	TRANSISTOR	
Q8			2SB1565	TRANSISTOR	
Q9,10			2SC4081	TRANSISTOR	
Q11			2SB1565	TRANSISTOR	
Q12			DTC144EUA	DIGITAL TRANSISTOR	
Q13			UMC2N	TRANSISTOR	
Q15			2SB1565	TRANSISTOR	
Q16			2SC4617	TRANSISTOR	
Q25			2SB1188(Q,R)	TRANSISTOR	K2K3M1
Q26			DTC114YUA	DIGITAL TRANSISTOR	K2K3M1
Q27			2SB1188(Q,R)	TRANSISTOR	
Q28			2SA1576A	TRANSISTOR	
Q29			DTA114EUA	DIGITAL TRANSISTOR	
Q30			DTC114YE	DIGITAL TRANSISTOR	
Q30		*	PDTC114YE	TRANSISTOR	M1E1E
Q31			DTA123JK	DIGITAL TRANSISTOR	
Q32			DTC144EUA	DIGITAL TRANSISTOR	
Q33			2SC4081	TRANSISTOR	
Q34		*	2SA1774	TRANSISTOR	
Q35			2SC4617	TRANSISTOR	
Q36			2SC4081	TRANSISTOR	
Q37-40			DTA124EUA	DIGITAL TRANSISTOR	E
Q37-40			DTA124EUA	DIGITAL TRANSISTOR	K3M1E1
Q37,38			DTA124EUA	DIGITAL TRANSISTOR	K2
Q40			DTA124EUA	DIGITAL TRANSISTOR	K2
Q41			2SA1576A	TRANSISTOR	
Q42			DTC124EUA	DIGITAL TRANSISTOR	
Q43			DTC143TUA	DIGITAL TRANSISTOR	E1E
Q44			DTC124EUA	DIGITAL TRANSISTOR	
Q45			2SB1188(R)	TRANSISTOR	
Q46			DTC124EUA	DIGITAL TRANSISTOR	
Q47-50			DTC143TUA	DIGITAL TRANSISTOR	
Q55-57		*	DTC143TE	DIGITAL TRANSISTOR	E1E
Q56,57		*	DTC143TE	DIGITAL TRANSISTOR	K2K3M1

E : KDC-W6527 E1 : KDC-W6527Y K2 : KDC-MP625
K3 : KDC-MP6025 M1 : KDC-MP858

△ Indicates safety critical components.

PARTS LIST

* New parts

Parts without **Parts No.** are not supplied.

Les articles non mentionnés dans le **Parts No.** ne sont pas fournis.

Teile ohne **Parts No.** werden nicht geliefert.

ELECTRIC UNIT (X34-301x-xx/X34-3222-70)

Ref. No.	Add	New	Parts No.	Description	Destination
Q58,59			DTC143TUA	DIGITAL TRANSISTOR	E
Q58,59			DTC143TUA	DIGITAL TRANSISTOR	K3M1E1
Q60			DTC124EUA	DIGITAL TRANSISTOR	
TH1		*	PRF21BD471QB2	POSITIVE RESISTOR	
A1		*	W02-3439-05	ELECTRIC CIRCUIT MODULE	
A2	2D	*	X86-3760-11	FRONT-END UNIT	K2K3M1
A2	2D	*	X86-3762-70	FRONT-END UNIT	E1
A2	2D		X86-3762-71	FRONT-END UNIT	E
CD MECHANISM ASSY (X92-4850-00)					
2	1B		A10-4827-32	CHASSIS	
5	1B	*	D10-4576-83	ARM ASSY	
8	2A		D10-4579-13	LEVER ASSY	
10	2A		D10-4581-13	ARM	
11	2A		D10-4582-13	ARM	
12	3A		D10-4583-03	ARM	
13	3A		D10-4584-03	ARM	
14	3B		D10-4585-03	ARM	
15	2A		D10-4586-13	SLIDER	
16	3B	*	D10-4587-42	SLIDER	
17	2B		D10-4588-13	SLIDER	
18	2B		D10-4595-04	ARM	
19	3B	*	D10-4596-24	ARM	
22	2A		D13-2151-04	GEAR	
23	2B		D13-2152-04	GEAR	
24	3B		D13-2153-04	GEAR	
25	3B		D13-2154-04	GEAR	
26	3B		D13-2155-04	WORM	
27	2B		D13-2156-14	GEAR	
28	3B		D13-2157-04	GEAR	
29	3B		D13-2158-04	GEAR	
30	2B		D13-2168-04	GEAR	
31	3B		D13-2171-04	GEAR	
32	2B	*	D13-2172-13	RACK (GEAR)	
33	2A		D14-0759-04	ROLLER	
35	2B		D21-2382-04	SHAFT	
36	1A		D23-0954-04	RETAINER	
37	1B		D39-0246-05	DAMPER	
38	2B		G01-3072-04	EXTENSION SPRING	
39	2A		G01-3073-04	TORSION COIL SPRING	
40	2A		G01-3074-04	EXTENSION SPRING	
41	1B		G01-3075-14	EXTENSION SPRING	
42	2A		G01-3076-04	EXTENSION SPRING	
43	1B		G01-3077-14	EXTENSION SPRING	
44	2B		G02-1399-04	FLAT SPRING	
45	2B		G02-1408-04	FLAT SPRING	
51	1A	*	J21-9676-32	MOUNTING HARDWARE	
52	3B		J21-9677-22	MOUNTING HARDWARE	
53	1B		J21-9678-13	MOUNTING HARDWARE	
55	1A		J90-1001-11	GUIDE	
56	1B		J90-1023-03	GUIDE	
A	2B		N09-4460-05	TAPTITE SCREW (OVAL P TAPTIT)	
B	1B		N09-4472-15	MACHINE SCREW (M1.7X8.0)	

Ref. No.	Add	New	Parts No.	Description	Destination
C	2B		N09-6004-05	MACHINE SCREW (M1.7X2.5 IB-L)	
E	2B		N09-6007-05	MACHINE SCREW (PAN M2X2)	
F	1A		N09-6051-05	TAPTITE SCREW (BIND P 2X5)	
G	2A		N19-2163-04	FLAT WASHER	
H	1B		N39-2020-46	PAN HEAD MACHIN SCREW	
J	1B		N09-6108-05	MACHINE SCREW (M2*3.5TYPE3)	
K	3B		N09-6155-05	SEMS (TAPTITE SCREW) (PT2X6)	
DM1	3B		T42-1066-04	DC MOTOR ASSY (SP)	
DM2	2B		T42-1067-04	DC MOTOR ASSY (LO)	
DPU1	2B		X93-2010-00	OPTICAL PICKUP ASSY	

E : KDC-W6527 E1 : KDC-W6527Y K2 : KDC-MP625
K3 : KDC-MP6025 M1 : KDC-MP858

△ Indicates safety critical components.

SPECIFICATIONS

KDC-MP6025/MP625/MP858

● FM

Frequency Range (Frequency step)

KDC-MP6025/MP625	87.9MHz~107.9MHz (200kHz)
KDC-MP858	87.5MHz~108.0MHz (50kHz) 87.9MHz~107.9MHz (200kHz)

Channel Space Selection	50k/200kHz
Usable Sensitivity (S/N 30dB)	9.3dBf (0.8 μ V/75 Ω)
Quieting Sensitivity (S/N 50dB)	15.2dBf (1.6 μ V/75 Ω)
Frequency Response (\pm 3.0dB)	30Hz~15kHz
S/N	70dB (MONO)
Selectivity (DIN)	\geq 80dB (\pm 400kHz)
Stereo Separation	40dB (1kHz)

● AM

Frequency Range (Frequency step)

KDC-MP6025/MP625	530kHz~1700kHz (10kHz)
KDC-MP858	531kHz~1611kHz (9kHz) 530kHz~1700kHz (10kHz)

Channel Space Selection	9k/10kHz
Usable Sensitivity (S/N 20dB)	28dB μ (25 μ V)

● CD

Laser Diode	GaAlAs
Digital Filter (D/A)	8 Times OverSampling
D/A Converter	1 Bit
Spindle Speed (rpm)	1000~400 (CLV · 2 times)
Wow & Flutter	Below Mesurable Limit
Frequency Response	10Hz~20kHz (\pm 1dB)
Total Harmonic Distortion	0.01% (1kHz)
S/N Ratio	105dB (1kHz)
Dynamic Range	93dB
Channel Separation	96dB
MP3 Decode	Compliant with MPEG-1/2 Audio Layer-3
WMA Decode	Compliant with WINDOWS MEDIA AUDIO

● Preout Level/Load-Unbalanced 2000mV/10k Ω (CD/CD-CH)

● Preout Impedance \leq 600 Ω

● AUX Input (KDC-MP6025/MP858)

Frequency Response	20Hz~20kHz (\pm 1dB)
Input Maximum Voltage	1200mV
Input Impedance	100k Ω

● AMP

Maximum Power	50W x 4
Full Bandwidth Power (at less than 1% THD)	22W x 4

● TONE

Bass	100Hz \pm 10dB
Middle	1kHz \pm 10dB
Treble	10kHz \pm 10dB

● GENERAL

Operating voltage (11~16V allowable)	14.4V
Current Consumption	10A
Installation Size (W x H x D)	182 x 53 x 155 mm 7-3/16 x 2-1/16 x 6-1/10 in
Weight	1.40kg (3.09lbs)

KENWOOD CORPORATION

2967-3, Ishikawa-machi, Hachioji-shi, Tokyo, 192-8525 Japan

KENWOOD USA CORPORATION
P.O. Box 22745, 2201 East Dominguez Street, Long Beach, CA 90801-5745, U.S.A.

KENWOOD ELECTRONICS CANADA INC.
6070 Kestrel Road, Mississauga, Ontario, Canada L5T 1S8

KENWOOD ELECTRONICS LATIN AMERICA S.A.
P.O. Box 55-2791 Paillilla, Plaza Credicorp Bank Panama,
Piso 9, Oficina 901, Calle 50, Panama, Rep. de Panama

KENWOOD ELECTRONICS BRASIL LTDA.
Alameda Ministro Rocha Azevedo No. 456,
Edifício Jaú, 10o Andar, Cerqueira César, Cep 0140-001,
São Paulo-SP-Brasil

KENWOOD ELECTRONICS UK LIMITED
Kenwood House, Dwight Road, Watford, Herts, WD18 9EB, United Kingdom

KENWOOD ELECTRONICS DEUTSCHLAND GMBH
Rembrücker-Str. 15, 63150 Heusenstamm, Germany

KENWOOD ELECTRONICS FRANCE S.A.
13, Boulevard Ney, 75018 Paris, France

KENWOOD ELECTRONICS BELGIUM N.V.
Leuvensesteenweg 248 J, 1800 Vilvoorde, Belgium

KDC-W6527/W6527Y

● FM

Frequency Range (Frequency step)	87.5MHz~108.0MHz (50kHz)
Usable Sensitivity (S/N 26dB)	0.7 μ V/75 Ω
Quieting Sensitivity (S/N 46dB)	1.6 μ V/75 Ω
Frequency Response (\pm 3.0dB)	30Hz~15kHz
S/N	65dB (MONO)
Selectivity (DIN)	\geq 80dB (\pm 400kHz)
Stereo Separation	35dB (1kHz)

● MW (AM)

Frequency Range (Frequency step)	531kHz~1611kHz (9kHz)
Usable Sensitivity (S/N 20dB)	25 μ V

● LW

Frequency Range	153kHz~281kHz
Usable Sensitivity (S/N 20dB)	45 μ V

● CD

Laser Diode	GaAlAs
Digital Filter (D/A)	8 Times OverSampling
D/A Converter	1 Bit
Spindle Speed (rpm)	1000~400 (CLV · 2 times)
Wow & Flutter	Below Mesurable Limit
Frequency Response	10Hz~20kHz (\pm 1dB)
Total Harmonic Distortion	0.01% (1kHz)
S/N Ratio	105dB (1kHz)
Dynamic Range	93dB
Channel Separation	96dB
MP3 Decode	Compliant with MPEG-1/2 Audio Layer-3
WMA Decode	Compliant with WINDOWS MEDIA AUDIO

● Preout Level/Load-Unbalanced 2000mV/10k Ω (CD/CD-CH)

● Preout Impedance \leq 600 Ω

● AUX Input

Frequency Response	20Hz~20kHz (\pm 1dB)
Input Maximum Voltage	1200mV
Input Impedance	100k Ω

● AMP

Maximum Power	50W x 4
PWR DIN45324, +B=14.4V	30W x 4

● TONE

Bass	100Hz \pm 10dB
Middle	1kHz \pm 10dB
Treble	10kHz \pm 10dB

● GENERAL

Operating voltage (11~16V allowable)	14.4V
Current Consumption	10A
Installation Size (W x H x D)	182 x 53 x 155 mm
Weight	1.40kg (3.09lbs)

KENWOOD follows a policy of continuous advancements in development. For this reason specifications may be changed without notice.

KENWOOD ELECTRONICS ITALIA S.p.A.
Via G. Sirtori 7/9, 20129 Milano, Italy

KENWOOD IBÉRICA S.A.
Bolivia, 239-08020 Barcelona, Spain

KENWOOD ELECTRONICS AUSTRALIA PTY. LTD. (A.C.N. 001 499 074)
16 Giffnock Avenue, Centrecourt Estate, North Ryde,
N.S.W. 2113, Australia

KENWOOD ELECTRONICS (HONG KONG) LTD.
Unit 3712-3724, Level 37, Tower 1, Metroplaza, 223 Hing Fong Road, Kwai Fong, N.T.,
Hong Kong

KENWOOD ELECTRONICS GULF FZE
P.O. Box 61318, Jebel Ali, Dubai, U.A.E.

KENWOOD ELECTRONICS (THAILAND) CO., LTD.
956 Udom Vidhya Building (Olympia) Rama IV Road, Silom, Bangrak, Bangkok 10500 Thailand

KENWOOD ELECTRONICS SINGAPORE PTE. LTD.
1 Genting Lane, #07-00, Kenwood Building, Singapore, 349544

KENWOOD ELECTRONICS (MALAYSIA) SDN BHD
#4.01 Level 4, Wisma Academy Lot 4A, Jalan 19/1, 46300 Petaling Jaya, Selangor Darul Ehsan,
Malaysia